

**CONTENTS**

**TABLE OF CONTENTS** ..... **1**

**SECTION 1—WASP SETUP** ..... **5**

    SECTION 1.1—WASP ..... 6

        ZONE OF NEUTRALITY: LEFT AND RIGHT CHANNEL ..... 6

        SPEAKER PLACEMENT VERSUS LISTENING POSITION ..... 9

        SPEAKER ORIENTATION ..... 11

**SECTION 2—SABRINA ASSEMBLY** ..... **15**

    SECTION 2.1—UNCRATING THE SABRINA ..... 16

        INITIAL CHECK..... 16

        UNCRATING THE SABRINA..... 16

    SECTION 2.2 – BOX CONTENT CHECKLIST ..... 17

**SECTION 3—SETUP OF SABRINA** ..... **19**

    SECTION 3.1—SETTING UP SABRINA ..... 20

        PREPARATION ..... 20

    SECTION 3.2—SABRINA SPIKES ..... 20

## 2 SABRINA INSTALLATION AND CARE GUIDE

ASSEMBLY.....	21
SECTION 3.3—WIRING ATTACHMENTS .....	21
SECTION 3.4—REMOVING THE PROTECTIVE FILM .....	22
SECTION 3.5—RESISTORS .....	23
WOOFER DAMPING (Q) RESISTOR.....	23
REPLACING AN OPEN RESISTOR.....	24
<b>SECTION 4—SPECIFICATIONS .....</b>	<b>27</b>
SECTION 4.1—SPECIFICATIONS:.....	28
SECTION 4.2—GRAPHICAL DIMENSIONS.....	29
SECTION 4.3—SABRINA PHASE CURVE .....	30
SECTION 4.4—SABRINA IMPEDANCE CURVE.....	31
<b>SECTION 5—WARRANTY .....</b>	<b>33</b>
SECTION 5.1—WARRANTY DETAILS.....	34
LIMITED WARRANTY.....	34
CONDITIONS .....	34
REMEDY.....	35

TABLE OF CONTENTS 3

WARRANTY LIMITED TO ORIGINAL PURCHASER ..... 36

DEMONSTRATION EQUIPMENT..... 36

MISCELLANEOUS ..... 37



# SECTION 1—WASP SETUP

## Section 1.1—WASP

An instructional video outlining the Wilson Audio Setup Procedure (WASP) can be found here: [wilsonaudio.com/WASP](http://wilsonaudio.com/WASP). The proper positioning of your new Sabrina within your room is critical in order to extract its formidable performance envelope. When carefully followed, the WASP has proven to be the most effective method for setting up Wilson loudspeakers. Your authorized Wilson dealer is trained in this process, and is the best resource for you to ensure your loudspeakers are set up properly.

Viewing the video is the best way to learn how to properly employ WASP, but we have also included an outline of it here.

### **Zone of Neutrality: Left and Right Channel**

The “Zone of Neutrality” is an area in your room where the speakers will sound most natural. This location is where the speakers interact the least with adjacent room boundaries. It is important to have a clear working space while determining the Zone of Neutrality.

The following is a simple method to locate the Zone of Neutrality within your listening environment:

1. Stand against the wall BEHIND the location where you intend to position your loudspeakers. Speaking in a moderately loud voice and at a constant volume, project your voice out into

the room. Your voice will have an overly heavy, “chesty” quality because of your proximity to the rear wall.

2. While speaking, slowly move out into the room, progressing in a direction parallel to the sidewall. It is helpful to have another listener seated in the listening position to assist you during this process. Listen to how your voice “frees up” from the added bass energy imparted by the rear wall boundary. Also notice that your voice is quite spatially diffuse (to your assistant, your voice will sound spatially large and difficult to localize) as you begin to ease away from the rear wall.
3. At some point during your progression forward into the room, you will observe a sonic transition in your voice; it will sound more tonally correct and less spatially diffuse (your assistant can now precisely localize the exact origin of your voice). When you hear this transition, you have entered the inner edge of the Zone of Neutrality. Place a piece of tape on the floor to mark this location. Although it will vary from room to room, in most rooms the zone begins between two and a half to three feet from the rear wall.
4. Continue to walk slowly away from the rear wall. After some distance, usually one to two feet past the first piece of tape, you will begin to hear your voice lose focus and appear to

# 8

## SABRINA INSTALLATION AND CARE GUIDE

reflect (echo) in front of you. This is caused by the return of the room's boundary contribution; your voice is now interacting with the opposite wall. At the point where you begin to hear the reflected sound of your voice, you have reached the outer edge of the Zone of Neutrality. Place a piece of tape on the floor and mark this location. The distance between the "inner" and "outer" edge tape marks is usually between eight inches (for small, interactive rooms) and three feet (for large, more neutral rooms).

5. Now position yourself against the side wall perpendicular to the intended speaker location. Stand between the two tape marks. Using the same procedure as above, begin moving into the room toward the opposite sidewall, progressing between the two pieces of tape. As above, listen for the point in the room where your voice transitions from bass-heavy and diffuse to neutral. Mark this point with tape. Continue your progression until there is an obvious interaction with the opposite wall in front of you and mark this point with tape. The four pieces of tape now form a rectangle that establishes the Zone of Neutrality for the loudspeaker to be installed on that side of the room. Using the four marks as your guide, tape an outline to define the boundaries of the rectangle.



6. Repeat this process for each speaker location individually. These are your Zones of Neutrality, one for each channel.

Theoretically, the Zone of Neutrality for any room runs like a path, parallel to the walls all around the room. Adjacent to very large windows and open doors, the outer edge of the Zone of Neutrality moves closer to the wall and becomes wider. If you were to extend the inner and outer boundaries of the Zone for the sidewalls and the front wall (behind the speakers), they would intersect.

### **Speaker Placement Versus Listening Position**

The location of your listening position is as important as the careful setup of your Wilson Audio loudspeakers. The listening position should ideally be no more than 1.1 to 1.25 times the distance between the tweeters on each speaker. Therefore, in a long, rectangular room of 12' x 18', if the speaker tweeters are going to be 9' apart, you should be sitting 9'11" to 11'3" from the speaker. This would be more than halfway down the long axis of the room.

Many people place the speakers on one end and sit at the other end of the room. This approach will not yield the finest sound. Carefully consider your listening position. Our experience has shown that any listening position that places your head closer than 14" from a wall will diminish the sonic results of your listening due to the deleterious effects of boundary interaction.

# 10 SABRINA INSTALLATION AND CARE GUIDE

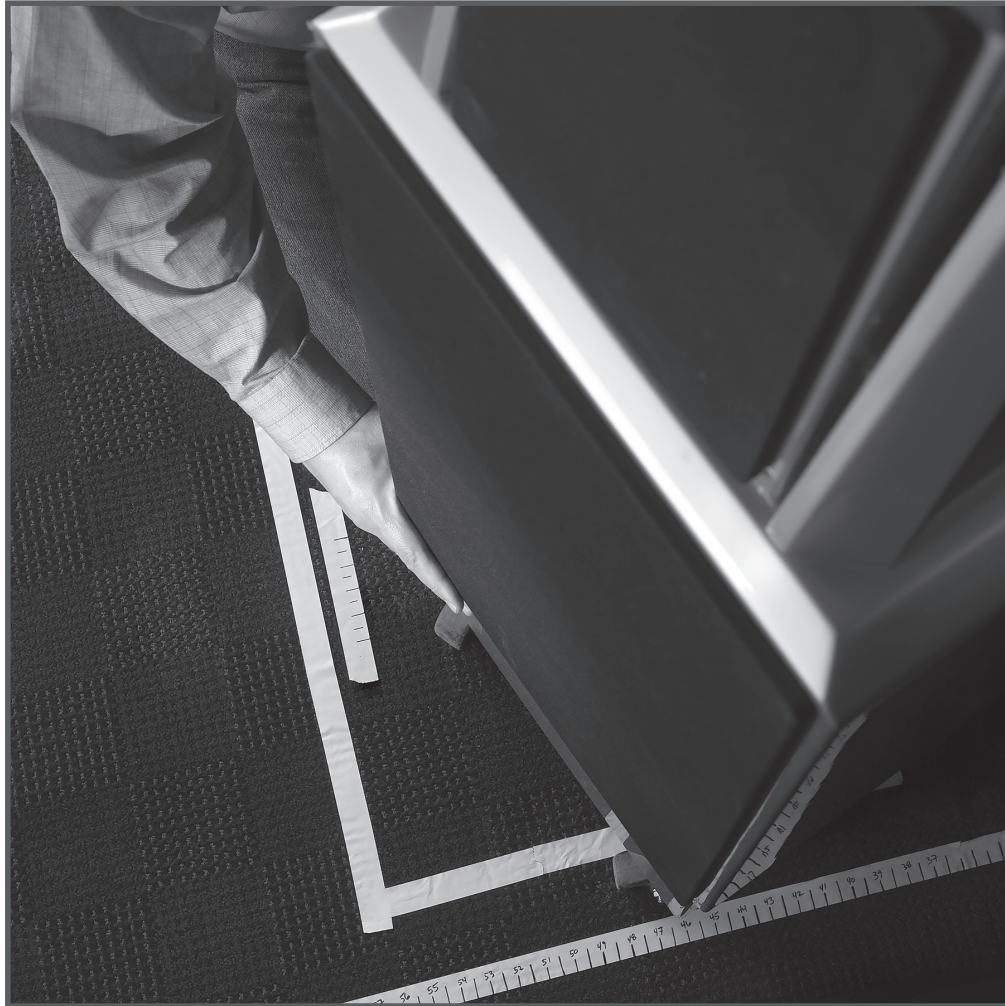

When carefully followed, the WASP has proven to be the most effective method for setting up Wilson loudspeakers.

## Speaker Orientation

Speaker placement and orientation are two of the most important considerations in obtaining superior sound. The first thing you need to do is eliminate the sidewalls as a sonic influence in your system. Speakers placed too close to the sidewalls will suffer from a strong primary reflection. This can cause out-of-phase cancellations, or comb filtering, which will cancel some frequencies and change the tonal balance of the music. Adhering to the Wilson Audio Setup Procedure outlined in the previous section is the best method with which to position your loudspeakers.

A very important aspect of speaker placement is how far from the back wall to place the speakers. The closer a loudspeaker is to the back wall, the more pronounced the low bass energy and centering of the image will be. However, this comes at a definite reduction in stage size and bloom as well as a deterioration of upper bass quality. You must find the proper balance of these two factors, but remember, if you are partial to bass response or air and bloom, do not overcompensate your adjustments to maximize these effects. Overcompensated systems are sometimes pleasing in the short-term, but long-term satisfaction is always achieved through proper balance.

To make correct in-home set up of the Sabrina possible without test

# 12 SABRINA INSTALLATION AND CARE GUIDE

equipment, Wilson Audio has measured the correct geometric time domain alignment for different distance/ear height combinations. See the next section for details. By measuring the distance from the speaker to the your ear when seated in the listening position, as well as height of the listener's ear measured from the floor, you will be able to align the system for your listening position.

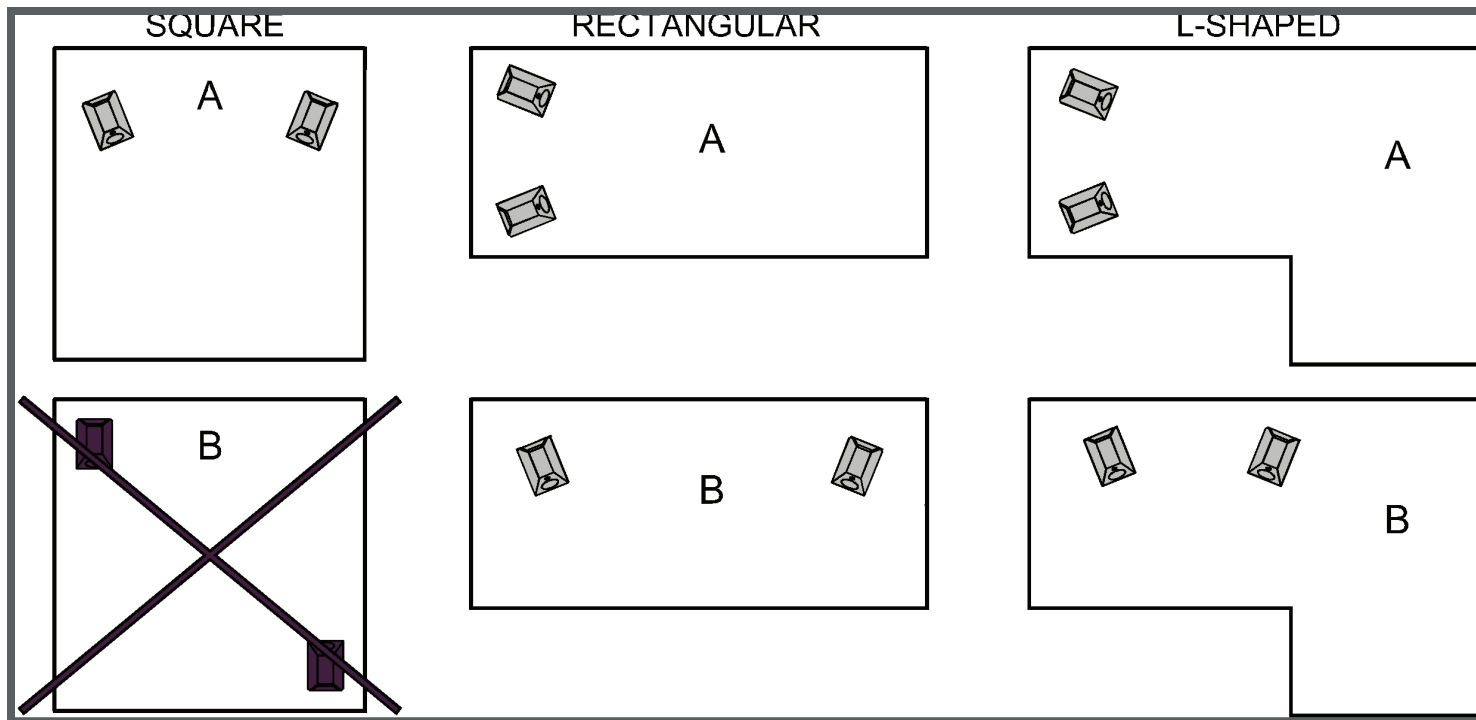





# SECTION 2—SABRINA ASSEMBLY

**Note: In your listening room or home theater, clear out two spaces, one for your left and one for your right channel. Place the ODD numbered Sabrina in the LEFT channel section and the EVEN in the RIGHT channel section.**

## Section 2.1—Uncrating the Sabrina

**Note: To avoid damaging the Sabrina’s painted surface. Please remove any jewelry such as rings, watches, necklaces, and bracelets during this process.**

### Initial Check

The Sabrinas are shipped in boxes. Upon receiving these boxes, please check their condition. If any of the boxes are damaged, please report it to the shipping company immediately for insurance verification.

**The following items are recommended for this procedure:**

- Box Cutter
- Phillips head drive bit
- Masking tape (for use in speaker setup)

### Uncrating the Sabrina

A minimum of two strong adults is required to set up the Sabrinas.

1. Carefully cut the metal bands around the box.
2. With the box facing up, carefully cut the tape securing the lid. Slide off the outer cardboard shell.



3. One box will contain the tool kit. Carefully remove the toolkit and the manual. Set these aside
4. Carefully lift the box upright so that the Sabrina is now vertical. With the Sabrina's bottom toward the floor and one person holding the box, the second person should reach in and gently slide the Sabrina out of the box.
5. Place the Sabrina with an odd serial number on the left side of the room and the Sabrina with an even serial number on the right side of the room.

**Note: The Sabrinas are very heavy and care should be taken to prevent injury.**

## Section 2.2 – Box Content Checklist

Now that you have unpacked your Sabrina, you can inventory all the additional items in the boxes.

- Owners Manual
- Warranty Registration Form
- Polishing Cloth
- 8x Spike with Nut
- 8x Aluminum Spike Pads
- 1/2" Nut Driver (binding posts)
- 9/16 Combo Wrench (spike nuts)
- 5/32" Ball-End Allen (driver screws)
- 1/8" Ball-end Allen head for bottom resistor panel



# SECTION 3—SETUP OF SABRINA

**Note: Before setting up the Sabrina, study carefully Section 2, “In Your Room.” It provides valuable information on determining the ideal room location for your speakers.**

## Section 3.1—Setting up Sabrina

### Preparation

You will need the following items:

- Supplied hardware kit
- Tape measure
- Known listening position

Your dealer is trained in the art and science of the Wilson Audio Setup Procedure (WASP) outlined in Section 2. Before the spike assemblies are attached to the bottom of your Sabrinas, the set up and fine tuning of your loudspeaker should be completed. Before spiking your Sabrinas, use masking tape to carefully mark their location.

## Section 3.2—Sabrina Spikes

The Sabrina comes with a set of heavy duty spikes (see Figure 3). These spikes also provide a secure mechanical reference point as well as optimal height placement for the Sabrina. Aluminum disks that fit beneath the spikes

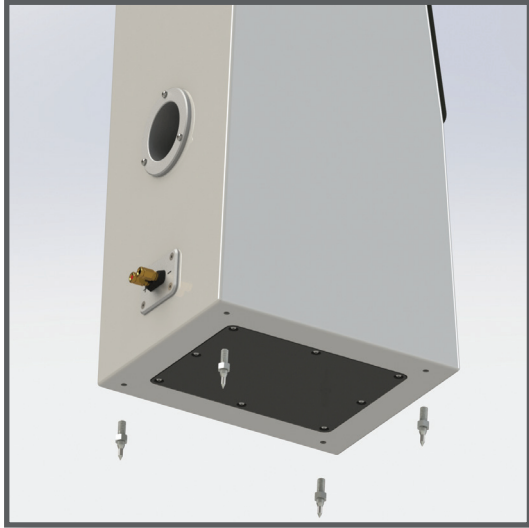

are also included for installations where spikes might damage the floor surface (such as wood floors).

After determining the optimal Sabrina position, assemble the spikes as follows:

### Assembly

1. Screw the spike (with nut) all the way in until the nut just touches the bottom of the enclosure. Do not tighten the nut at this time. Three threads should be visible beneath the nut.
2. Repeat steps 1 through 4 with the other spikes.
3. Adjust the spikes so that the Sabrina is level.
4. Using the 9/16" combination wrench, tighten the nut snug against the diode to prevent the spike assembly from coming loose.

## Section 3.3—Wiring Attachments

Very high quality binding post connections are provided to facilitate connecting Sabrina to your amplifier. Locate the 1/2" nut driver from your tool kit. Attach the main output from the amplifier to the binding posts located on the bottom rear of the Sabrina. Use the 1/2" nut driver to tighten the binding posts.

**Do not overtighten.**

## Section 3.4—Removing the Protective Film

To protect the finish of the Sabrina during final manufacture, shipment, and setup in your listening room, we have applied a removable layer of protective film over the finish. We recommend that this film be left in place until the speakers are in their final location in your listening room. Once you have determined their final position, remove the film by following this procedure:

1. Ensure the speaker surface is room temperature before removing the protective film. Removing the protective film when the speaker surface is cold can damage the paint surface.
2. Slowly remove the film from the top down, large sections at a time, gently pulling the film downward and outward. Tearing the film aggressively can damage the paint.
3. Take care in removing the protective film near edges and corners to prevent paint damage in these areas.
4. The protective film should not be left on the painted surface for extended periods of time nor exposed to heat sources and direct sunlight.

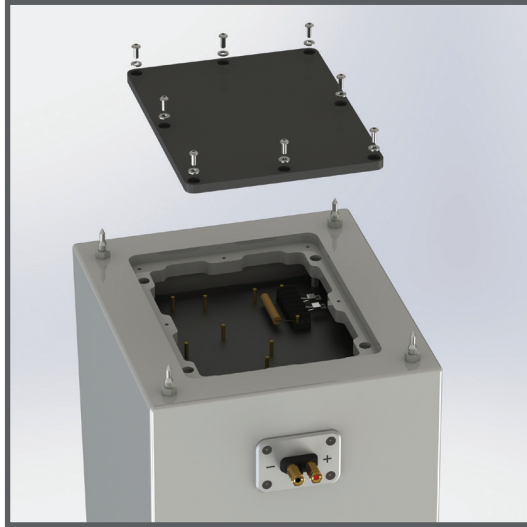

## Section 3.5—Resistors

By removing the X-material cover on the bottom of your Sabrinas, you may gain access to the resistor strip (see Figure 4). These resistors serve several functions.

**Note: Only Wilson Audio replacement resistors should be used in your Sabrinas. Changing the value or brand of resistor will have a deleterious affect on the sonic performance of your loudspeakers and will void your Wilson Audio Warranty.**

### Midrange and Tweeter Resistors

The Midrange Level, which consists of two 6.8 ohm resistors in parallel, and Tweeter Level, which consists of two 11.75 ohm resistors in parallel, resistors provide precise level matching for the midrange and tweeter drivers correspondingly. The resistors also act as ultra high quality fuses which open before a driver can be damaged by excess power. See Section 6.0 for details in replacing these resistors in the event one of these resistors is damaged.

Additionally, these resistors can be used to tailor the output of the corresponding driver to overcome tonal balance issues that result from room acoustics.

### Woofers Damping (Q) Resistor

The Woofer Damping (Q) resistor affects the way the Sabrina's woofers

couple to the amplifier. These resistors are pre-installed and should not be changed.

## Replacing an Open Resistor

The resistors are designed such that they will open before damage occurs to the corresponding driver. In the event a resistor is damaged, use the following procedure to replace it.

- Power off the amplifier.
- Disconnect the speaker cable from the Sabrina.
- Lay a terry cloth towel or soft blanket on the floor adjacent to the Sabrina to cushion the painted side of the loudspeaker.
- Make sure to apply masking tape on the floor to mark the placement of your Sabrina to ensure you can return them to their proper location.
- Carefully lay the Sabrina on its side. You will now have access to the bottom access panel, under which is the crossover and resistor access.
- Remove the screws securing the crossover access panel with the provided 1/8-inch ball-end wrench.
- Identify the resistor that needs to be replaced.
- Using a flathead screwdriver, remove the screws securing the resistor to the plate. Take care to prevent the screws from dropping into the enclosure.



- Remove the heatsink from damaged resistor.
- Install the heatsink onto the replacement resistor.
- Re-install the resistor.
- Replace the access door.
- Take care to reposition the Sabrinas in their original location, using the masking tape as the guide.

The resistors, located behind the plate on the bottom of the Sabrina, act as an ultra-high-quality fuse which opens before a driver can be damaged by excess power.

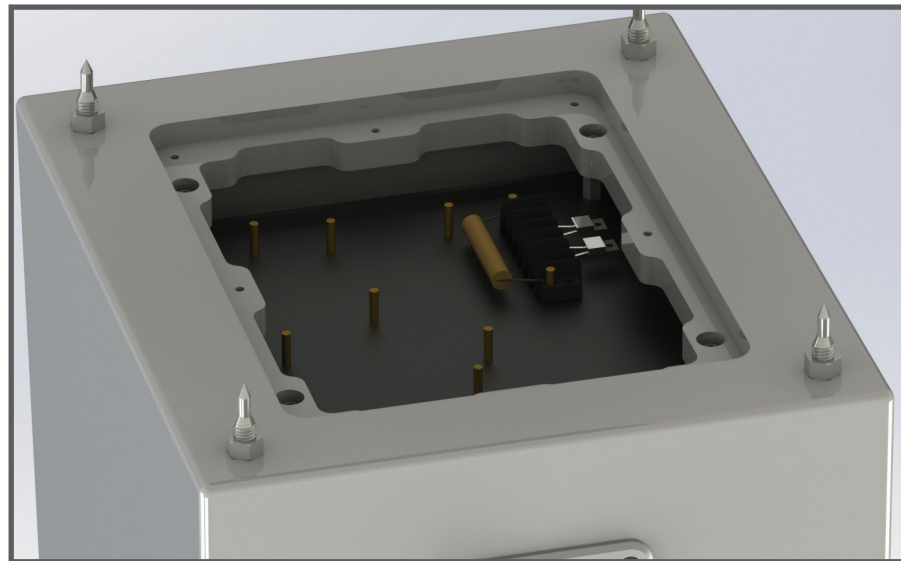



# SECTION 4—SPECIFICATIONS

## Section 4.1—Specifications:

**Enclosure Type Sabrina:** Rear Ported

**Woofers:** 8 inches (20.32 cm) paper cone

**Tweeter:** 1 inch Dome (2.54 cm) Doped Silk Fabric

**Midrange:** 5 3/4 inches (14.61 cm) Paper Pulp

**Sensitivity:** 87 dB @ 1W @ 1m @ 1 kHz

**Nominal Impedance:** 4 ohms / 2.53 ohms minimum @ 139 Hz

**Minimum Amplifier Power:** 50 Watts per channel

**Frequency Response:** 31 Hz – 21 kHz: +/- 3 dB: Room Average Response [RAR]

**Overall Dimensions:** Height: 38 inches (96.48 cm)

Height with spikes: 39 5/16 inches (99.80 cm)

Width: 12 inches (30.48 cm)

Depth: 15 3/16 inches (38.55 cm)

**System Weight Per Channel:** 94 lbs (42.64 kg)

**System Shipping Weight (approx.):** 222 lbs (100.70 kg)

Section 4.2—Graphical Dimensions

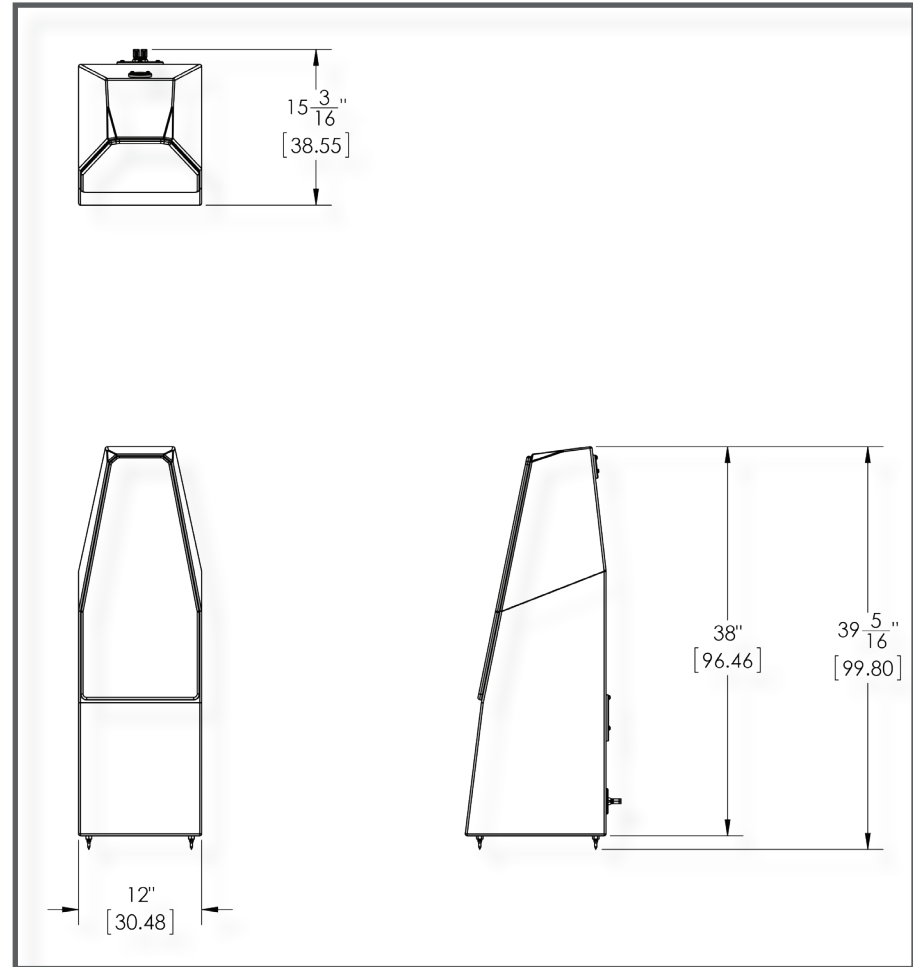

## Section 4.3—Sabrina Phase Curve

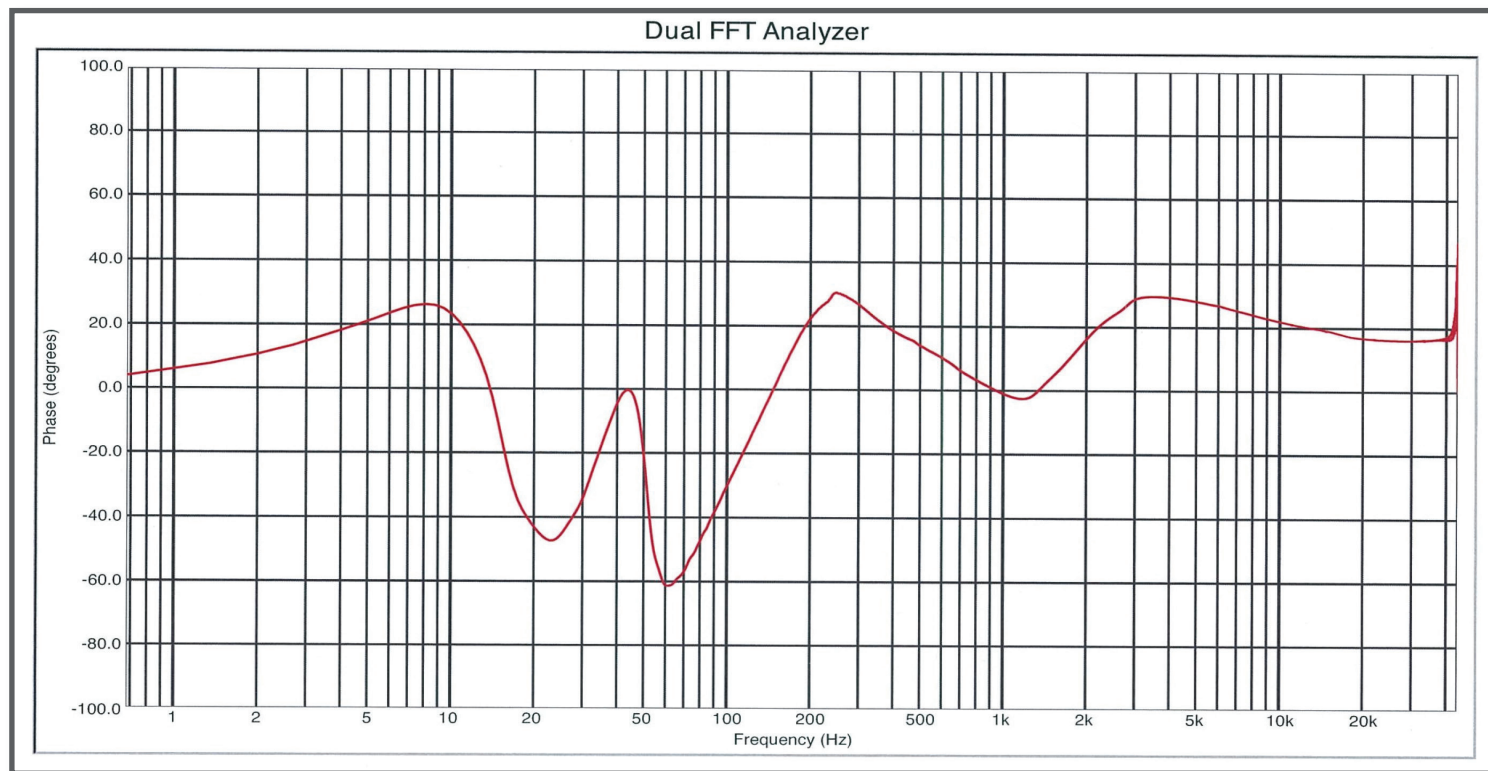

## Section 4.4—Sabrina Impedance Curve

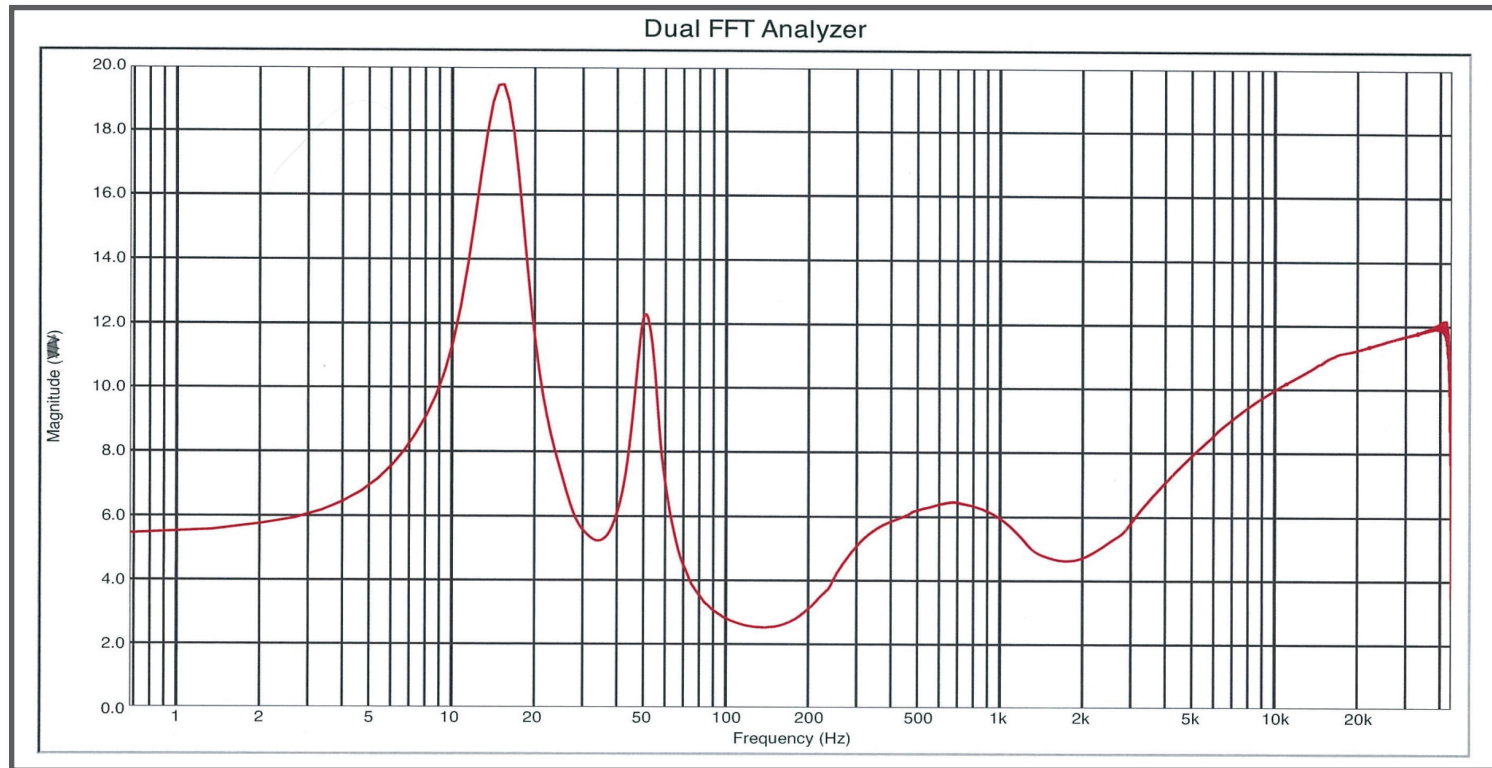





# SECTION 5—WARRANTY

## Section 5.1—Warranty Details

### Limited Warranty

Subject to the conditions set forth herein, Wilson Audio warrants its electronics to be free of manufacturing defects in material and workmanship for the Warranty Period. The Warranty Period is a period of 90 days from the date of purchase by the original purchaser, or if both of the following two requirements are met, the Warranty Period is a period of five (5) years from the date of purchase by the original purchaser:

**Requirement No. 1. No later than 30 days after product delivery to the customer, the customer must have returned the Warranty Registration Form to Wilson Audio. Alternatively, the warranty may be filled out on-line.**

**Requirement No. 2. The product must have been professionally installed by the Wilson Audio dealer that sold the product to the customer.**

**FAILURE TO COMPLY WITH EITHER REQUIREMENT NO. 1 OR REQUIREMENT NO. 2 WILL RESULT IN THE WARRANTY PERIOD BEING LIMITED TO A PERIOD OF 90 DAYS ONLY.**

### Conditions

This Limited Warranty is also subject to the following conditions and limitations. The Limited Warranty is void and inapplicable if the product has been used or handled other than in accordance with the instructions in the owner's

manual, or has been abused or misused, damaged by accident or neglect or in being transported, or if the product has been tampered with or service or repair of the product has been attempted or performed by anyone other than Wilson Audio, an authorized Wilson Audio Dealer Technician or a service or repair center authorized by Wilson Audio to service or repair the product. Contact Wilson Audio at (801) 377-2233 for information on location of Wilson Audio Dealers and authorized service and repair centers. Most repairs can be made in the field. In instances where return to Wilson Audio's factory is required, the dealer or customer must first obtain a return authorization. Purchaser must pay for shipping to Wilson Audio, and Wilson Audio will pay for shipping of its choice to return the product to purchaser. A RETURNED PRODUCT MUST BE ACCOMPANIED BY A WRITTEN DESCRIPTION OF THE DEFECT. Wilson Audio reserves the right to modify the design of any product without obligation to purchasers of previously manufactured products and to change the prices or specifications of any product without notice or obligation to any person.

### **Remedy**

In the event that the product fails to meet the above Limited Warranty and the conditions set forth herein have been met, the purchaser's sole remedy under this Limited Warranty shall be to: (1) contact an authorized Wilson Audio Dealer within the Warranty Period for service or repair of the product without

charge for parts or labor, which service or repair, at the Dealer's option, shall take place either at the location where the product is installed or at the Dealer's place of business; or (2) if purchaser has timely sought service or repair and the product cannot be serviced or repaired by the Dealer, then purchaser may obtain a return authorization from Wilson Audio and at purchaser's expense return the product to Wilson Audio where the defect will be rectified without charge for parts or labor.

### **Warranty Limited to Original Purchaser**

This Limited Warranty is for the sole benefit of the original purchaser of the covered product and shall not be transferred to a subsequent purchaser of the product, unless the product is purchased by the subsequent purchaser from an authorized Wilson Audio Dealer who has certified the product in accordance with Wilson Audio standards and requirements and the certification has been accepted by Wilson Audio, in which event the Limited Warranty for the product so purchased and certified shall expire at the end of the original Warranty Period applicable to the product.

### **Demonstration Equipment**

Equipment, while used by an authorized dealer for demonstration purposes, is warranted to be free of manufacturing defects in materials and workmanship for a period of five (5) years from the date of shipment to the dealer. Demo

equipment needing warranty service may be repaired on-site or, if necessary, correctly packed and returned to Wilson Audio by the dealer at dealer's sole expense. Wilson Audio will pay return freight of its choice. A returned product must be accompanied by a written description of the defect. Dealer owned demonstration equipment sold at retail within two (2) years of date of shipment to the dealer is warranted to the first retail customer to be free of manufacturing defects in materials and workmanship for the same time periods as if the product had originally been bought for immediate resale to the retail customer. Wilson Audio products are warranted for a period of 90 days, unless extended to 5 years, as provided above, by return and filing of completed Warranty Registration at Wilson Audio within 30 days after product delivery to customer and the product was professionally installed by the Wilson Audio Dealer that sold the product to the customer.

### **Miscellaneous**

**ALL EXPRESS AND IMPLIED WARRANTIES NOT PROVIDED FOR HEREIN ARE HEREBY EXPRESSLY DISCLAIMED. ANY LEGALLY IMPOSED IMPLIED WARRANTIES RELATING TO THE PRODUCT SHALL BE LIMITED TO THE DURATION OF THIS LIMITED WARRANTY. THIS LIMITED WARRANTY DOES NOT EXTEND TO ANY INCIDENTAL OR CONSEQUENTIAL COSTS OR DAMAGES TO THE PURCHASER.**

**Some states do not allow limitations on how long an implied warranty lasts or an exclusion or limitation of incidental or consequential damages, so the**

**above limitations or exclusions may not apply to you. This Limited Warranty gives you specific legal rights, and you may also have other rights, which vary from state to state.**