

DUETTE

THE DUETTE OWNERS MANUAL



**WILSON
AUDIO**

Wilson Audio® is a registered trademark of Wilson Audio Specialties, Inc.

Cub®, Sophia®, WATT/Puppy®, Duette®, Alexandria®, and X-1/Grand SLAMM® are registered trademarks of Wilson Audio Specialties, Inc.

Duette™, Novel™, WATCH Center™, WATCH Surround™, and WATCH Dog™ are trademarks of Wilson Audio Specialties, Inc.

This manual was produced by the Wilson Audio Engineering and Sales and the Marketing Department. The information contained herein is subject to change without notice. Current Revision 1.0. If you are in need of a more recent manual, please contact your dealer.

The information in this manual is the sole property of Wilson Audio Specialties, Inc. Any reproduction, in whole or in part, without the express written permission of Wilson Audio Specialties, Inc., is prohibited. No material contained herein may be transmitted in any form or by any means, electronic or mechanical, for any purpose, without the express written permission of Wilson Audio Specialties, Inc.

SECTION 1 – INITIAL SETUP 7

SECTION 1 – INITIAL INSTALLATION INFORMATION 9

 STAND MOUNT..... 9

 BOOKSHELF INSTALLATIONS..... 10

 CABINET INSTALLATIONS 11

SECTION 2 – DUETTE ON A STAND..... 13

SECTION 2.1 – CONFIGURING THE DUETTE FOR INSTALLATION 16

 INSTALLING THE TWEETER RESISTOR..... 16

SECTION 2.2 – INSTALLING THE DUETTE ON A STAND 17

 INSTALLING BRASS DISC RECEPTACLES IN DUETTE STAND 17

 ALIGNMENT CONES..... 18

 MOUNTING DUETTES ON THE DUETTE STAND 18

 FINAL POSITIONING OF THE DUETTE 19

 INSTALLING THE DUETTE STAND SPIKES 20

 LEVELING THE DUETTE STAND..... 20

SECTION 3 – DUETTE IN A BOOKSHELF 23

SECTION 3.1 – CONFIGURING THE DUETTE FOR INSTALLATION 25

SECTION 3.2 – INSTALLING THE TWEETER RESISTOR 30

 DUETTES ON SHELVING UNITS NEAR SOLID WALLS..... 30

SECTION 3.3 – ALIGNMENT CONES..... 31

 POSITIONING THE DUETTE ON BOOKSHELF..... 32

 POSITIONING DUETTE ON ITS SIDE..... 33

SECTION 4 – DUETTE IN A CABINET 35

SECTION 4.1 – CONFIGURING THE DUETTE FOR INSTALLATION 37

INSTALLING THE TWEETER RESISTOR	42
ALIGNMENT CONES	43
POSITIONING THE DUETTE IN CUSTOM CABINETS	44
POSITIONING DUETTE ON ITS SIDE	45
CABINET GRILL CLOTH	45
SECTION 5 – CARE OF DUETTE	47
SECTION 5.0 – CARE OF THE FINISH	49
REMOVING PROTECTIVE FILM	49
DUSTING THE DUETTE	50
CARE OF THE GRILLES	50
BREAK-IN PERIOD	51
SECTION 5.1 – ENCLOSURE TECHNOLOGY	51
MATERIALS	51
ADHESIVE	52
SECTION 5.2 – DEPTH OF DESIGN	52
SECTION 6 – IN YOUR ROOM	55
SECTION 6.1 – ROOM ACOUSTICS	57
FINAL LISTENING ROOM SETUP (VOICING)	57
ZONE OF NEUTRALITY	57
SECTION 6.2 – ROOM REFLECTIONS	59
SLAP ECHO	59
STANDING WAVES	61
COMB FILTER EFFECT	62
SECTION 6.3 – RESONANCES	64
STRUCTURAL RESONANCE	64
AIR VOLUME RESONANCE	64

SECTION 6.4 – YOUR ROOM	65
ROOM SHAPES	65
DUETTE IN A DEDICATED HOME THEATER	66
SPEAKER PLACEMENT VERSUS LISTENING POSITION	67
SPEAKER ORIENTATION	68
SUMMARY	68
SECTION 7 – SYSTEM SPECIFICATIONS	69
DUETTE DIMENSIONS	72
NOVEL DIMENSIONS	73
SECTION 8 – WARRANTY INFORMATION	75
SECTION 8.0 - WARRANTY INFORMATION	77
LIMITED WARRANTY	77
CONDITIONS	77
REMEDY.....	78
WARRANTY LIMITED TO ORIGINAL PURCHASER	78
DEMONSTRATION EQUIPMENT	79
MISCELLANEOUS.....	79

SECTION 1 - INITIAL SETUP



Section 1 – Initial Installation Information

Note: The Duette loudspeaker is configurable to suit its acoustic environment. In order to access the performance capabilities of your Duettes, it is critical that you adjust your Duettes correctly. This includes installing the proper umbilical cable, connecting the appropriate tweeter resistor, and mounting the correct geometric alignment cones.

Stand Mount



If you plan to install your Duettes on stands, please proceed to **Section 2**.

Bookshelf Installations

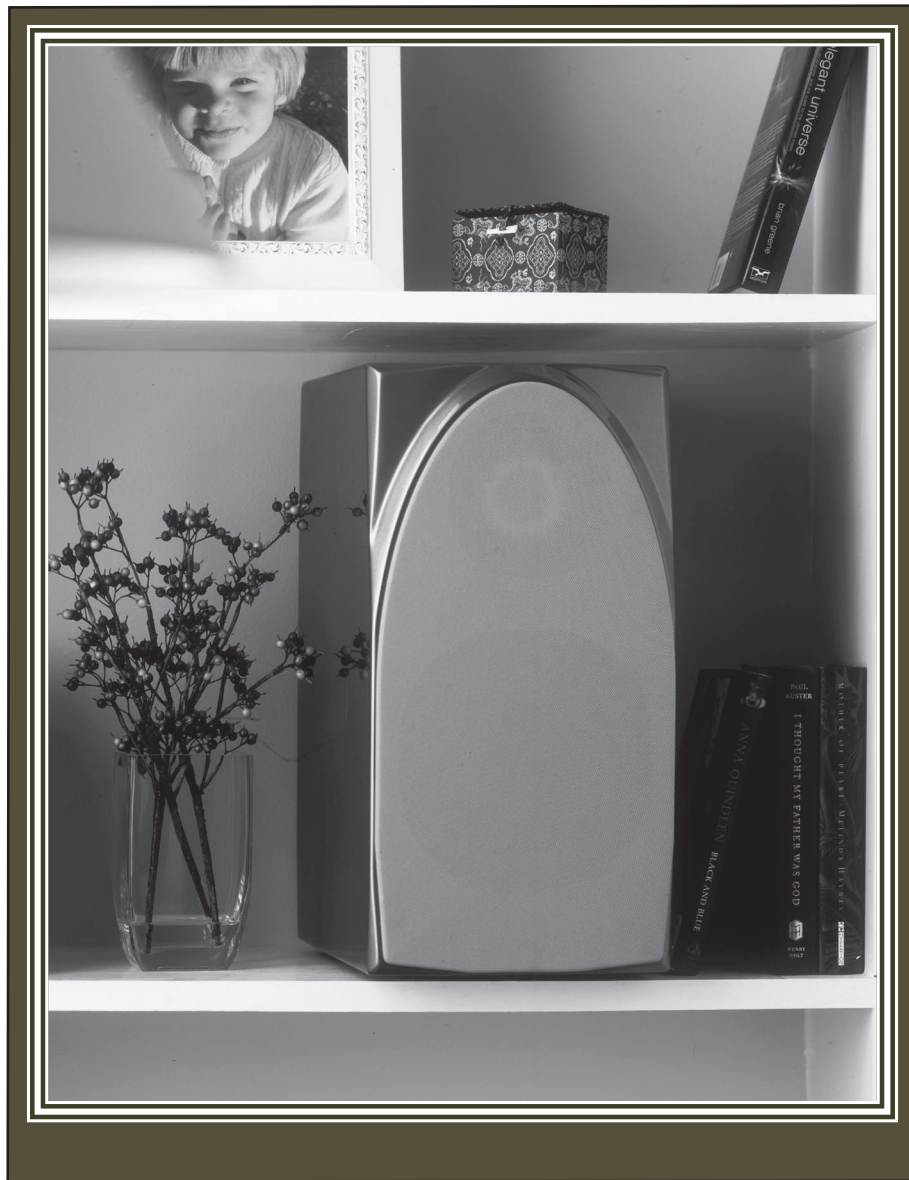

If you plan to install your Duettes on a bookshelf, please proceed to **Section 3**.

Cabinet Installations

If you plan to install your Duettes in custom cabinetry, please proceed to **Section 4**.



DUETTE

SECTION 2 - DUETTE ON A STAND



WILSON
AUDIO

Wilson Audio Specialties

Note: Please refer to the below tables to select the appropriate tuning resistor, umbilical cable, and cone options.

DUETTE STAND MOUNT - NEAR SOLID WALL	
RESISTOR	4.2 OHMS
UMBILICAL CABLE	BROWN CABLE
FRONT CONES	"A"
REAR CONES	"A"

Frequency in Hertz

2" TO 24"

SOLID WALL

DUETTE STAND MOUNT - AWAY FROM SOLID WALL (OR IN FRONT OF LARGE WINDOW)	
RESISTOR	5.3 OHMS
UMBILICAL CABLE	GRAY CABLE
FRONT CONES	"A"
REAR CONES	"A"

Frequency in Hertz

GREATER THAN 24 INCHES / .66 METER

SOLID WALL

Section 2.1 – Configuring the Duette for Installation

Installing the Tweeter Resistor

The Duette's tuning resistor, located on the rear of the Novel crossover, is one key to optimizing the performance of your Duettes.

Note: This resistor is not installed prior to shipping and must be installed before the Duette is connected.

If your Duettes are being installed near the wall, install the 4.2-ohm resistor into your Novel Crossover (See Figure 1). If your Duettes are being installed more than 24 inches (.66 meters) from the walls, install the 5.3-ohm resistor into your Novel Crossover (See Figure 1). Secure the resistor to the rear of the Novel crossover to the binding post labeled "Tweeter Resistor." Tighten the binding posts just enough so the resistor remains in place.

Locate the small resistor Allen screw. Loosen either binding post and position the metal tab of the resistor over the threaded holes. Carefully

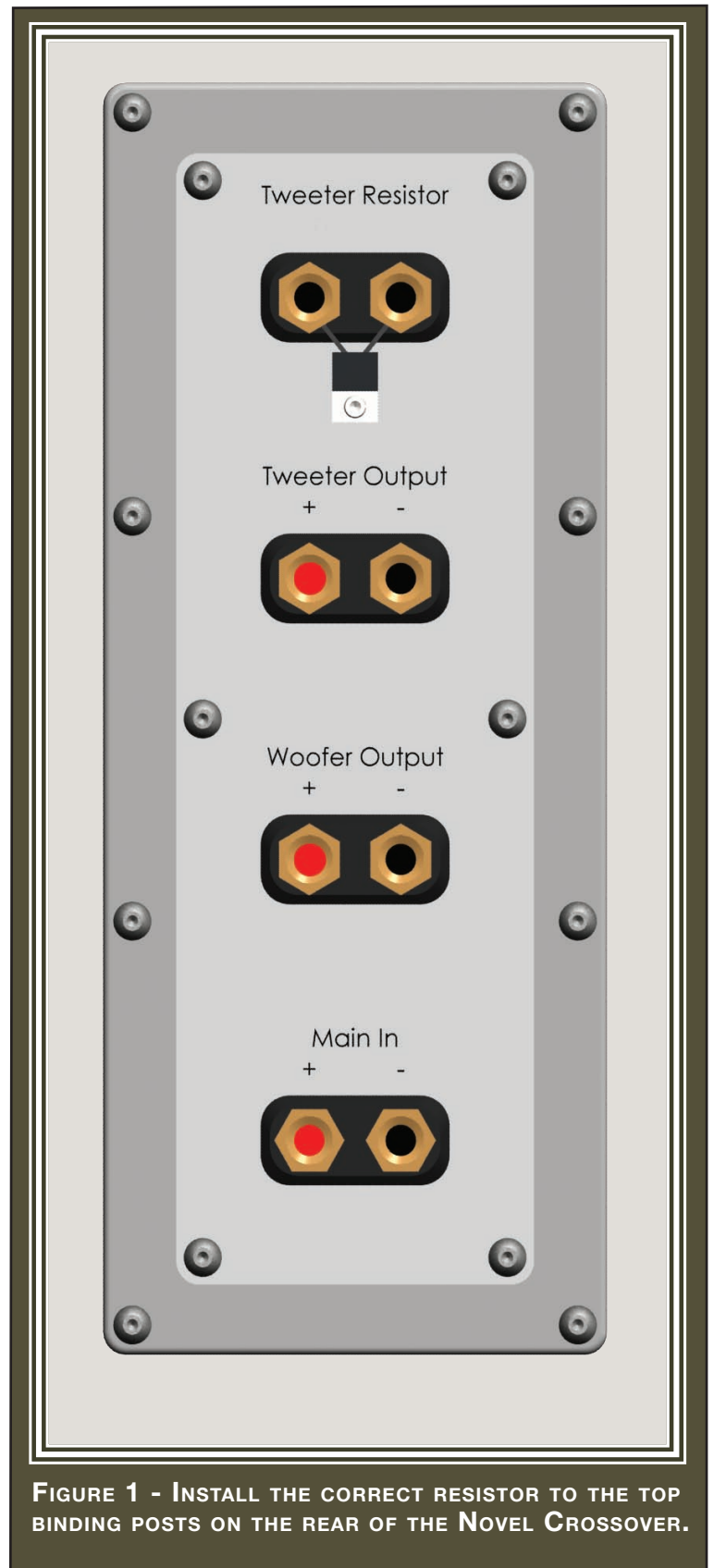

FIGURE 1 - INSTALL THE CORRECT RESISTOR TO THE TOP BINDING POSTS ON THE REAR OF THE NOVEL CROSSOVER.

install the Allen screw so that the resistor is snug against the rear plate.

Tighten the binding posts so that they are snug. Do not over tighten as this may result in damage to the binding post and/or the resistor leads. See Figure 1.

Section 2.2 – Installing the Duette on a Stand

Note: Refer to the instructions on page 49 that describe the safe procedure in removing the protective film from the Duettes. Remove the film at this time.



FIGURE 3 - THE GEOMETRIC CONES ARE SECURED VIA MAGNEPODS EMBEDDED IN THE DUETTE.

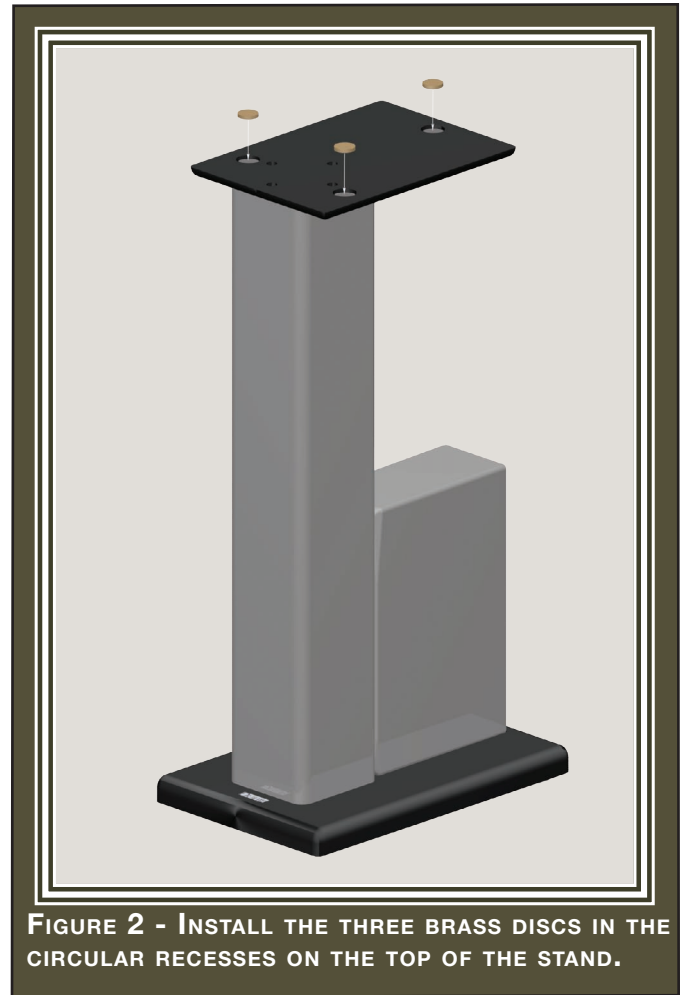

FIGURE 2 - INSTALL THE THREE BRASS DISCS IN THE CIRCULAR RECESSES ON THE TOP OF THE STAND.

Installing Brass Disc Receptacles in Duette Stand

Install the three brass discs into the machined recesses located on of the stand top plate. Make sure that the inverted cone detent of the brass disc faces up. See Figure 2.

Locate the putty in your setup kit. Prepare six pea-sized balls of the putty. Press the putty onto the center of each brass disc, compressing it to a 1/4 inch

(5 mm) circle over the cone indent.

Alignment Cones

There are three embedded magnets each on the bottom, left, and right sides of the Duette. Two are located near the front and one near the back of the Duette on each of these three sides. The magnets are embedded beneath the painted surface and are not visible (See Figure 3). This Magnepod™ (patent pending) attachment system allows the cones to be secured without additional hardware.

Your installation kit contains three cone sizes for geometric alignment tuning, labeled "A," "B," and "C." The code, which reflects size, is stamped into the base of each cone. Locate six (6) cones labeled "A."

Mounting Duettes on the Duette Stand

Note: The Duette stand is

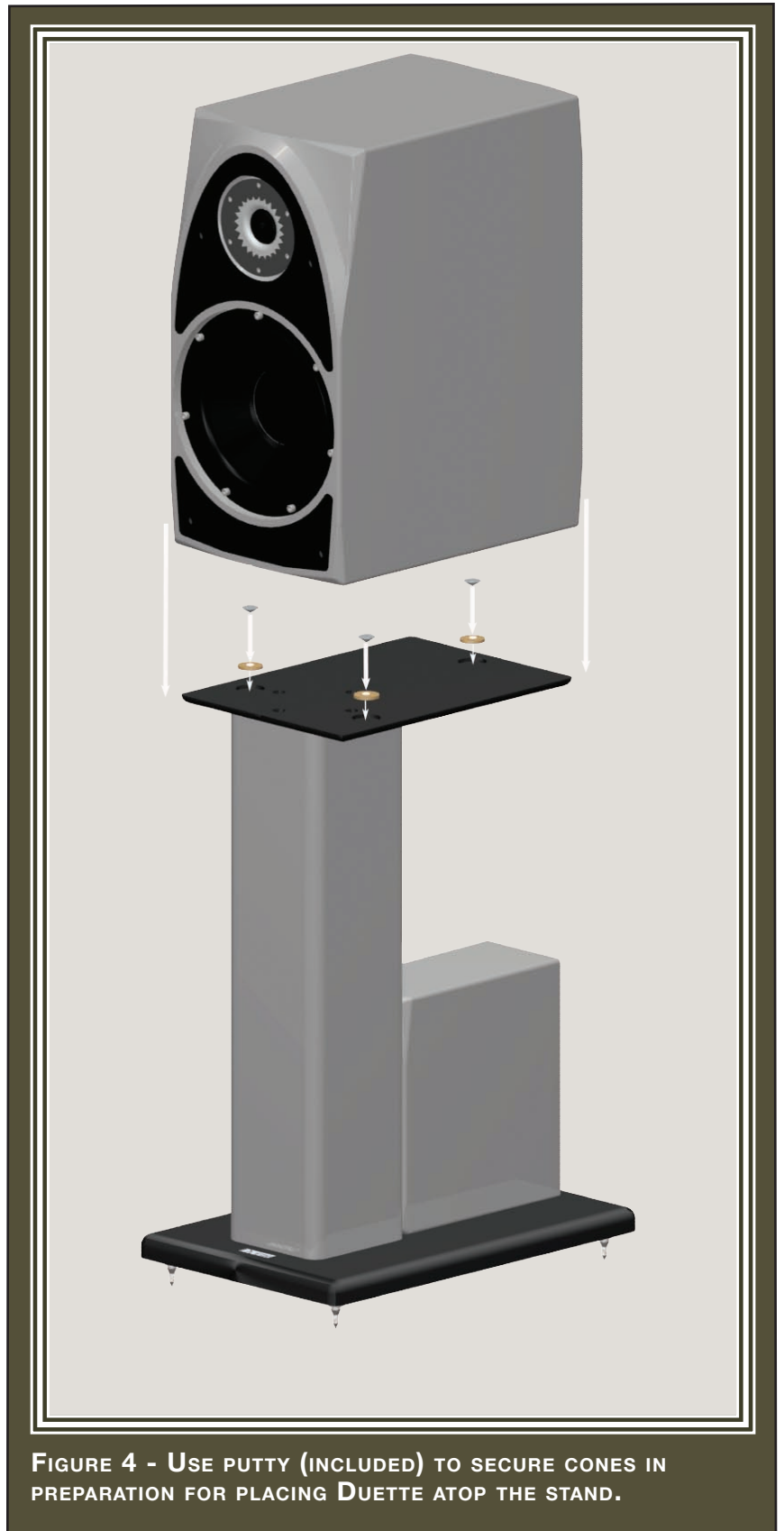

constructed from very high quality materials, such as Wilson’s proprietary “X” material. It has been optimized to compliment the Duette loudspeakers and requires no additional treatment or filling.

Carefully turn your Duette over and place it on its top on a surface that will not scratch its finish. Position three cones, flat side against the painted surface, on the bottom of the Duette over the Magnepods. The Magnepods will automatically position the cones at or very near their correct locations. Carefully press the putty side of each brass disc down onto one of the spike points. Seat the tip of the point firmly into the recess in the disc. Align each disc so that it is parallel with the bottom surface of the Duette. Turn the Duette over and carefully align the bottom of the Duette with the top plate of the stand. The brass discs should be directly above the recesses in the stand top plate. Lower the Duette so that discs seat down into the recesses.

Place the Novel Crossover into the machined recess on the lower stand plate. Using the appropriate umbilical (See the above table, page 15), attach the Novel to the Duette. The umbilical is configured with a separate woofer cable and tweeter cable. Attach the cable labeled “Tweeter” to the tweeter binding posts on the Duette and the Novel. Attach the woofer cable to the posts labeled “Woofer”.

Note: It is very important that you connect the umbilical properly. Failing to do so will greatly compromise the performance of your Duettes. Do not use a non-Wilson wire assembly between your Duette and Novel. This will severely compromise the performance of your Duettes and void your warranty.

Final Positioning of the Duette

Please refer to Section 6 for instruction on voicing your Duettes. Your Wilson Audio Dealer has been trained in the art of speaker setup and is your best resource in obtaining the best sonic result with your Duettes.

Note: Do not install the Duette Stand stand spikes until you have completed final setup.

Installing the Duette Stand Spikes

After carefully optimizing the location of the stand-mounted Duettes in the room, define the position of the Duettes using masking tape by marking the edge around the base of the stand. This will enable you to return your Duettes to their final setup location after you install the stand spikes. Remove the Duettes and Novel crossover from the stand.

Tip the stand on its end and insert spikes into the threaded holes on the underside of the lower stand plate. Leave the spike nuts loose at this time. Return the stand to its position marked by the tape and re-install the Duettes and the Novel crossover.

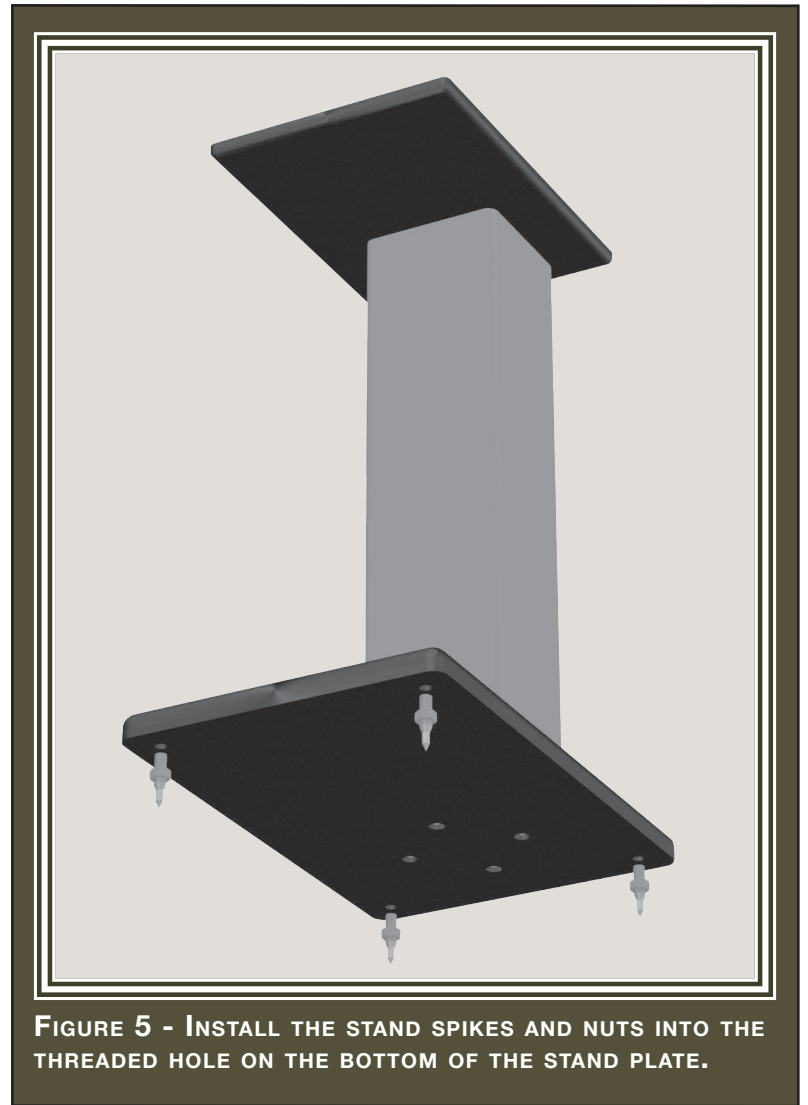

FIGURE 5 - INSTALL THE STAND SPIKES AND NUTS INTO THE THREADED HOLE ON THE BOTTOM OF THE STAND PLATE.

Leveling the Duette Stand

- Place a level on the left to right oriented axis in the top of the Duettes stand.
- If the bubble shows that the speaker is leaning toward the center of the room, you will have to lengthen one of the inside spikes down toward the floor. If the bubble is leaning toward the outside of the room, you will have to lengthen one of the outside spikes down toward the floor.

-
- You may rotate the spike tips in place by using a Vice-grip® or toothed pliers.
 - To find out which spike to lower, gently rock the stand back and forth. This will identify the stand spike that is out of level from the other three.
 - Place a level on the front to back oriented axis. If it is level, then your Duette stand is level. If the bubble shows that the stand is leaning toward the front of the room, you will have to lengthen the front stand spikes down toward the floor. If the bubble shows that the stand is leaning toward the back of the room (behind the loudspeakers), you will have to lengthen the rear stand spikes down toward the floor.

After you have leveled the Duette stands, use the 9/16 inch combination wrench to tighten the stand spike nuts up against the stand, taking care to not rotate the spike.

Wilson Audio Specialties

SECTION 3 - DUETTE IN A BOOKSHELF



Wilson Audio Specialties

Section 3.1 – Configuring the Duette for Installation

Note: Please refer to the table below to select the appropriate tuning resistor, umbilical cable, and alignment cone options based on the height of your shelf.

CONFIGURATION CHART					
ALL BOOKSHELF INSTALLATIONS USE THE BROWN NEAR WALL UMBILICAL					
	HEIGHT				
	0" - 15"	16" - 27"	28" - 39"	40" - 50"	>50"
FRONT CONES	C	B	A	A	A
REAR CONES	A	A	A	B	C
RESISTOR	4.2	4.2	4.2	4.2	4.2

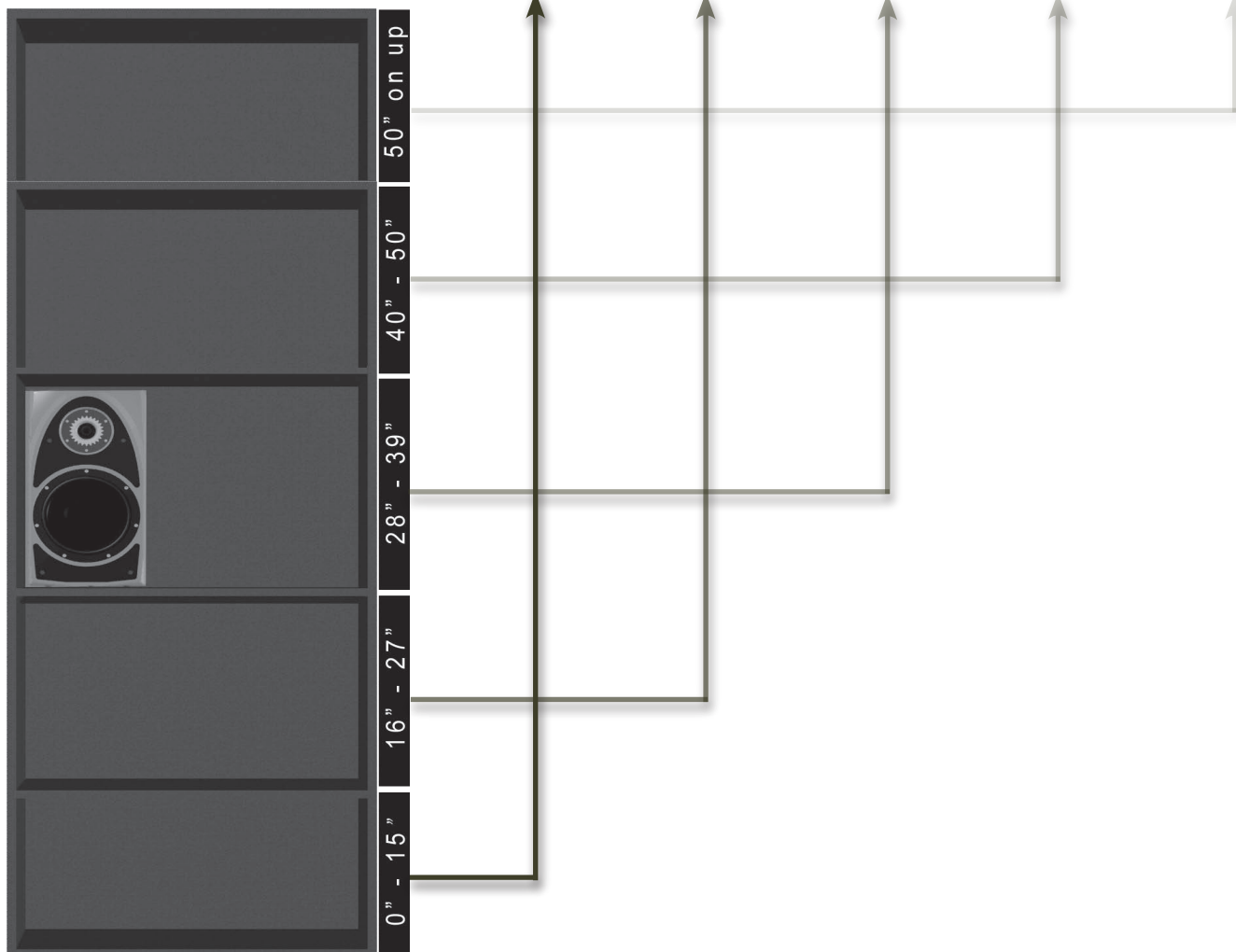

Note: The next three charts illustrate the effects of height on the frequency response of your Duette. Refer to the charts and determine which best applies to your installation. Understanding the changes in the tonal balance of the Duette at different heights will assist you in locating the optimal placement of your Duettes. It will as-

DUETTE PLACEMENT 3 TO 21 INCHES FROM THE FLOOR

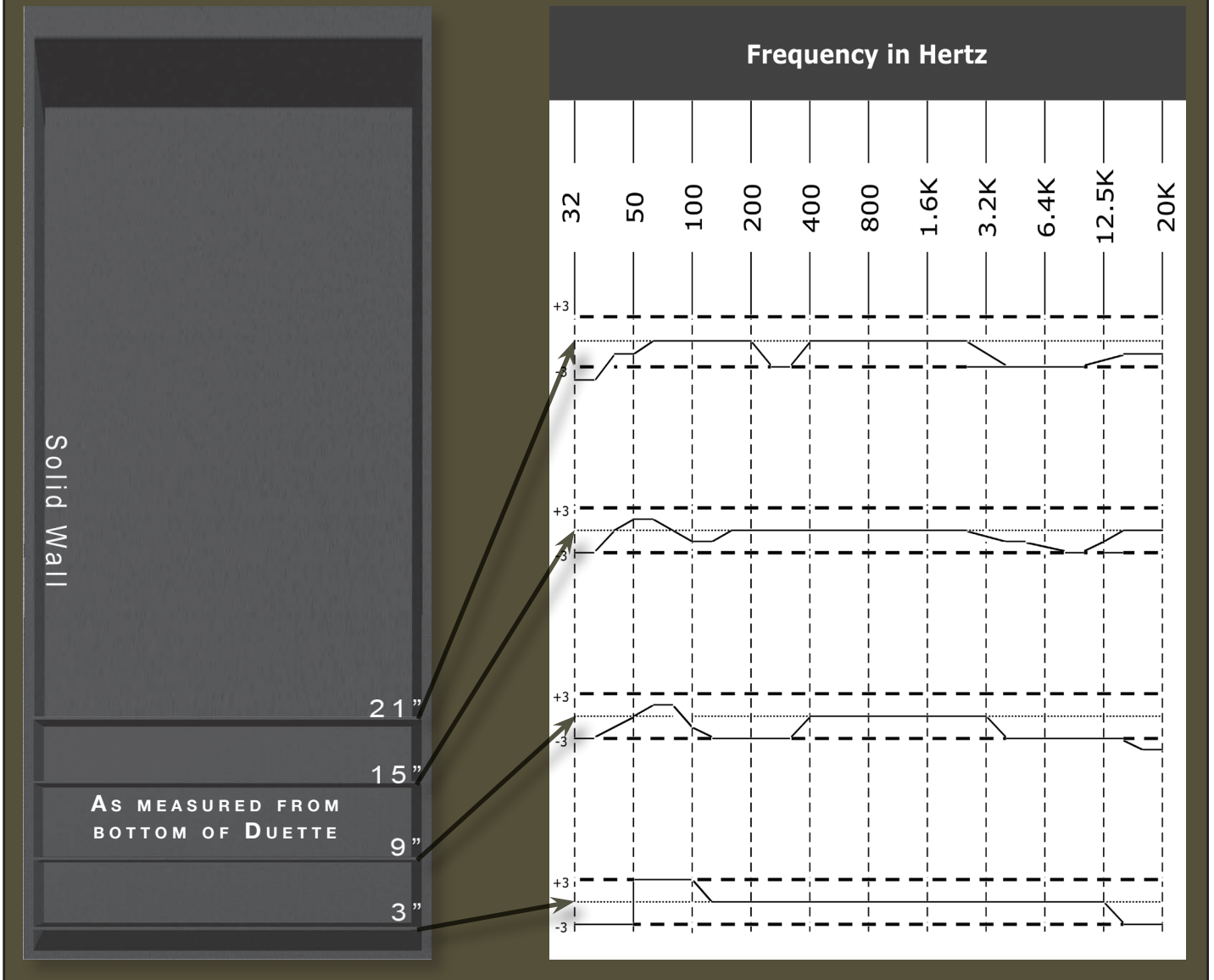

sist your efforts in optimizing Duette’s interaction with your particular room. All graphs assume the Duette is placed at least 24 inches (.51 meters) from the side walls. All measurements were performed with a microphone height of 44 inches (1.12 meters), placed on axis 8.5 (2.7 meters) feet from the loudspeakers.

DUETTE PLACEMENT 27 TO 45 INCHES FROM THE FLOOR

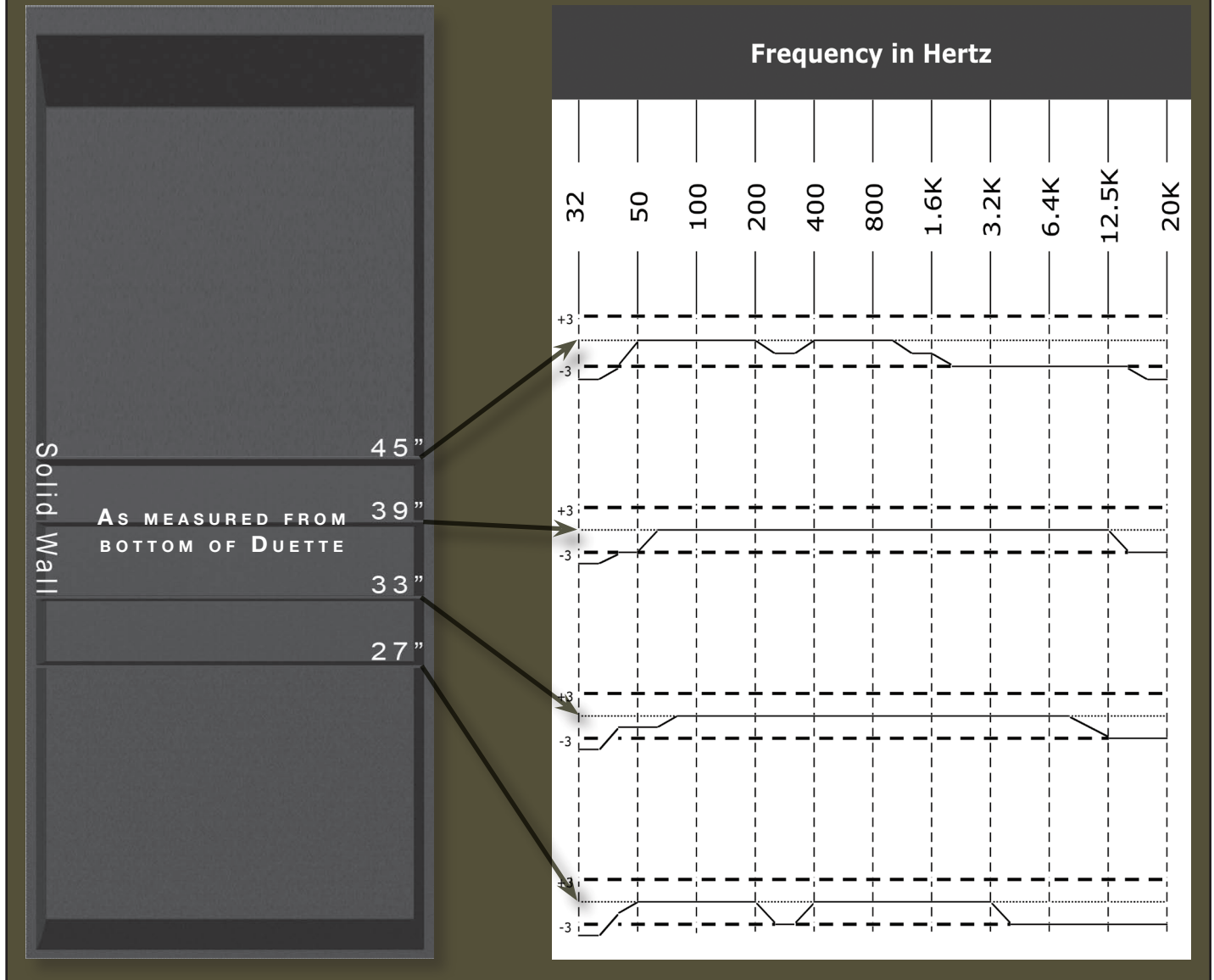

DUETTE PLACEMENT 51 TO 61 INCHES FROM THE FLOOR

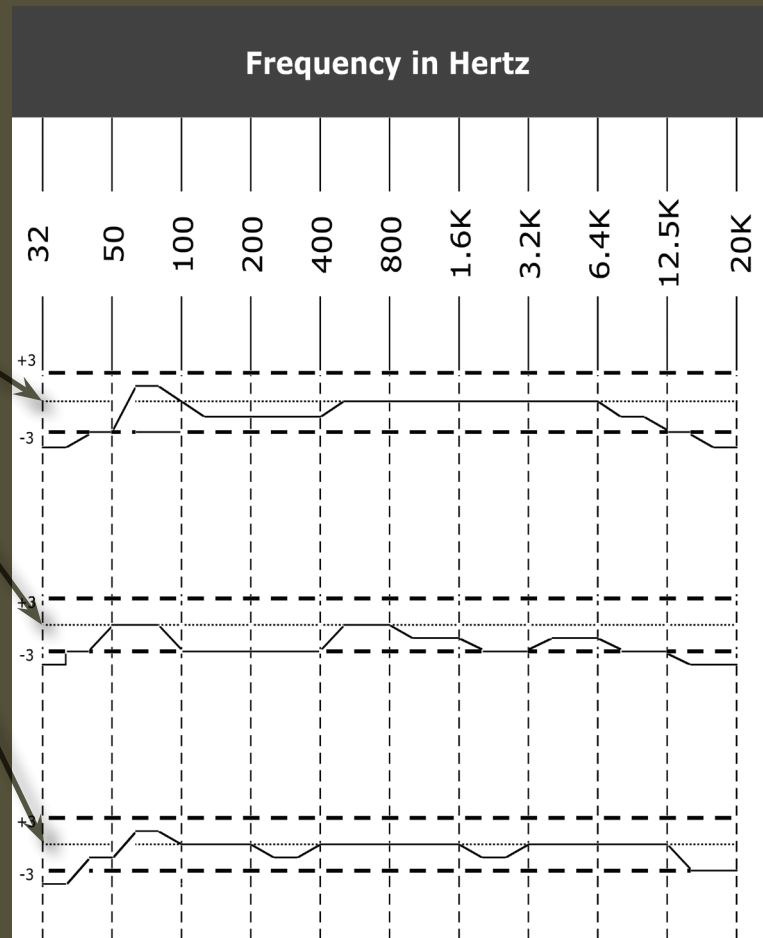
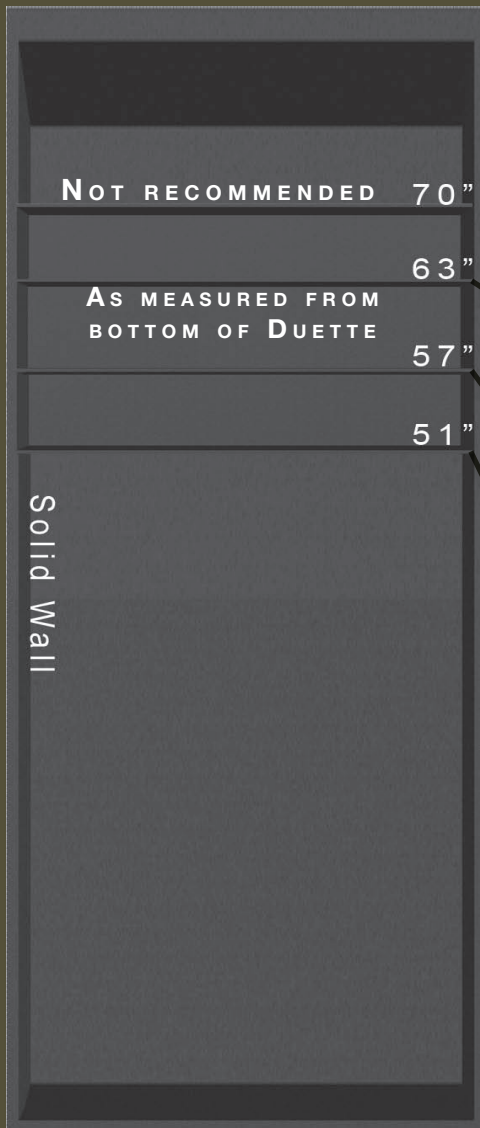

Refer to the chart below illustrating the boundary effects of the adjacent sidewall on your Duettes. Note that placement at least 18 inches (.46 meters) from the side wall provides more linear upper bass and midrange than will placement directly next to a side wall.

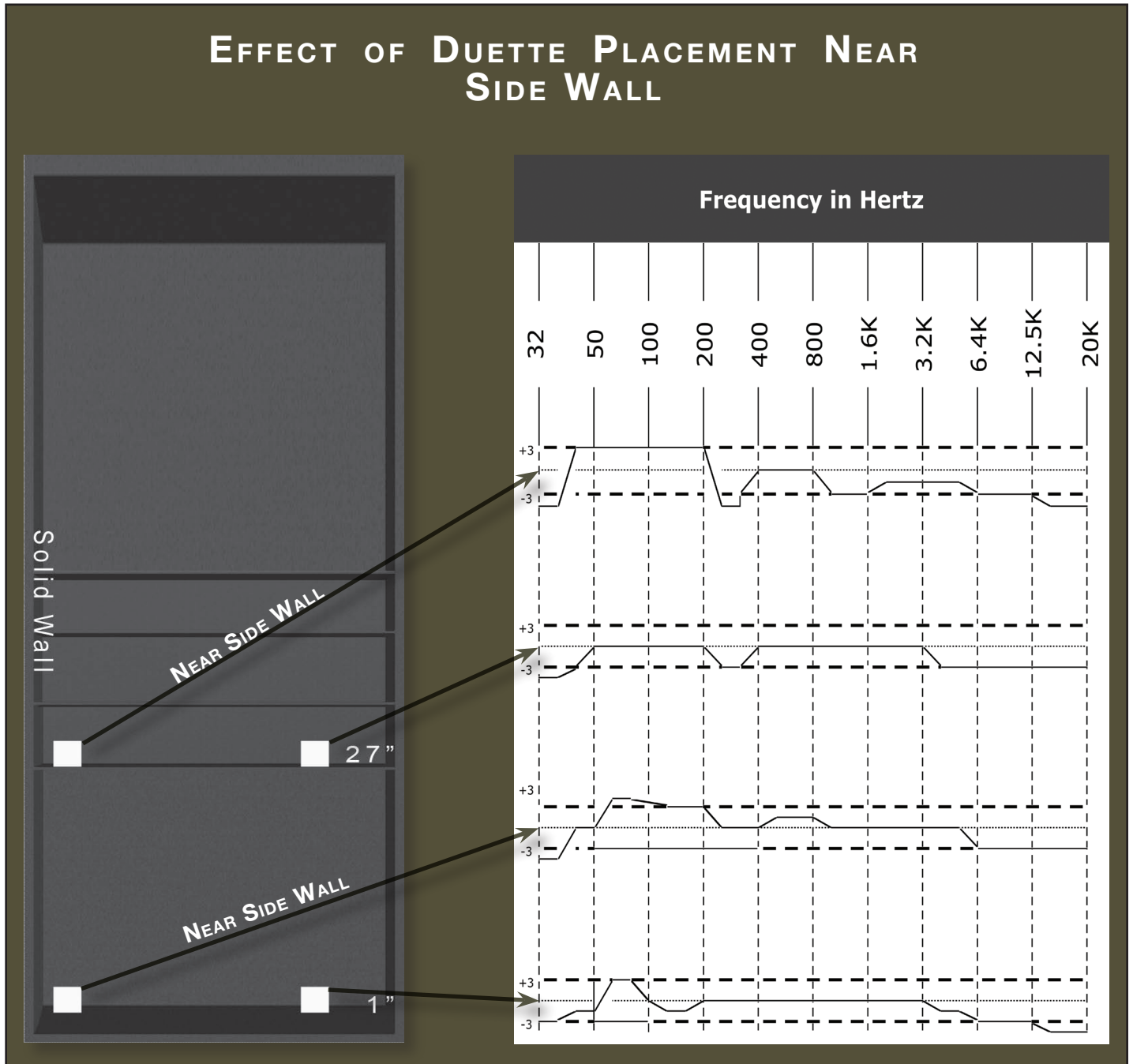

Section 3.2 – Installing the Tweeter Resistor

Duettes on Shelving Units Near Solid Walls

Note: the Duette's tuning resistor, located on the rear of the Novel crossover, is one key to optimizing the performance of your Duettes. This resistor is not installed prior to shipping and must be installed before the Duette is connected.

Locate the 4.2-ohm resistor in your Duette installation kit. Finger tighten the resistor to the top binding posts on the rear of the Novel crossover labeled "Tweeter Resistor." Tighten the binding posts just enough so the resistor remains in place.

Locate the small Allen screw. Loosen one of the binding posts and position the metal eye of the resistor over the threaded holes. Carefully thread the Allen screw through the resistor's tab and into the threaded hole so the resistor is snug against the rear plate.

Tighten the binding posts so that they are snug. Do not over tighten as

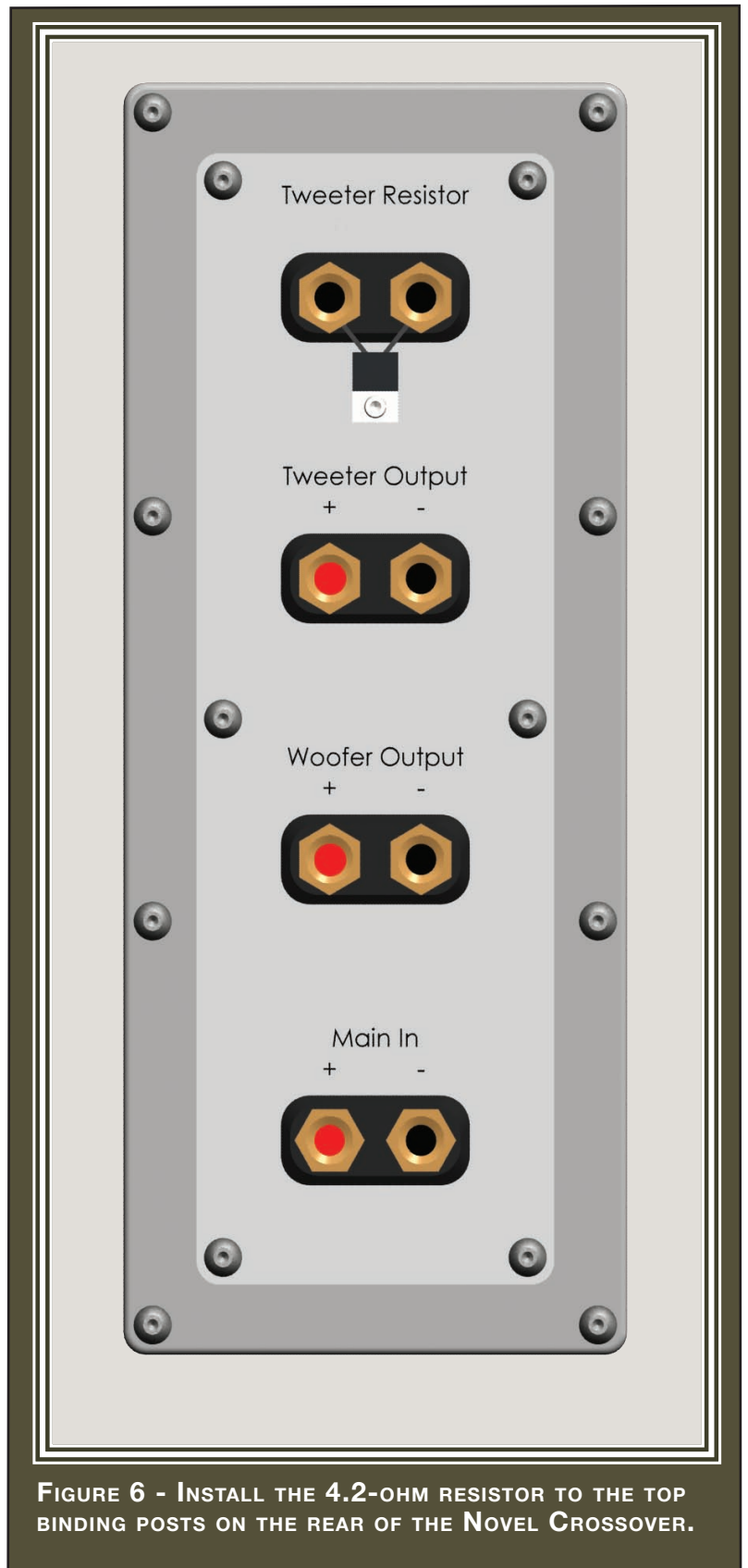

FIGURE 6 - INSTALL THE 4.2-OHM RESISTOR TO THE TOP BINDING POSTS ON THE REAR OF THE NOVEL CROSSOVER.

this may result in damage to the binding post and/or the resistor leads. See Figure 6.

Section 3.3 – Alignment Cones

Note: Refer to the instructions on page 49 that describe the safe procedure in removing the protective film from the Duettes. Remove the film at this time.

There are three embedded magnets each on the bottom, left, and right sides of the Duette. Two are located near the front and one near the back of the Duette on each of these three sides. The magnets are embedded beneath the painted surface and are not visible (See Figure 7). This Magnepod™ (patent pending) attachment system allows the cones to be secured without additional hardware.

Your installation kit contains three cone sizes for geometric alignment tuning, labeled “A,” “B,” and “C.” The code, which reflects size, is stamped into the base of each cone. Using the above chart (page 25), determine the cone combination that is appropriate for your installation. Remove the six cones from the installation kit.

Locate and remove the six brass discs, the round cone gaskets, and the putty from your setup kit. Prepare six pea-sized balls of the putty. Press the putty onto the center of each brass disc, compressing it to 1/4 inch (5mm) circle over the cone indent. Push the cone point into the putty until it seats in the brass disc indent. The putty will keep the cone and the brass disc together. Place the cone/disc assembly onto the bottom (or



FIGURE 7 - MAGNEPODS ARE LOCATED ON BOTH SIDES AS WELL AS THE BOTTOM OF THE DUETTE.

on the appropriate side) of your Duettes above the Magnepods. The magnetic force will center the cone in its proper location. The cones will now be attached to the Duette, secured by the Magnepods.

Remove the adhesive backing from an "O" shaped cone gasket and carefully place one over each cone. Smooth the gasket around the cone, making sure the adhesive has good contact to the bottom of the Duette. See Figure 8.

The Duette is now ready to place on the shelf.

Note: It is important to properly install the cone gasket to prevent the Duette from sliding on its cone.



FIGURE 8 - THE CONE GASKETS ARE INSTALLED OVER THE GEOMETRIC CONES.

Positioning the Duette on Bookshelf

Refer to the above tables and graphs (pages 26-29) to gain an understanding of how Duette's performance is affected by various vertical and horizontal placements. The Duette benefits from fine tuning both side to side as well as front to back tuning, within the constraints and limits of the shelf. The Duette should be slightly "toed-in" toward the listener, such that, from the seated position, the listener sees a small portion of the inside of each cabinet.

Note: Even when resting on its brass discs, take care when moving Duette as there is still risk of scratching the shelf beneath.

Positioning Duette on Its Side

In a sideways position, the tweeter should be positioned such that it is at a further distance from the listener than the woofer. To accomplish this, position the Duettes with the tweeter on the outside, woofers on the inside within the stereo pair.

The tweeter end of the Duette should be positioned slightly forward relative to the woofer. The Duette is thus toed-in toward the listener. The cone setup is the same for sideways setup as for vertical. As with a vertical setup, the Duette will perform better (as shown in Figure 9) away from the side wall. See also the graph on page 29.

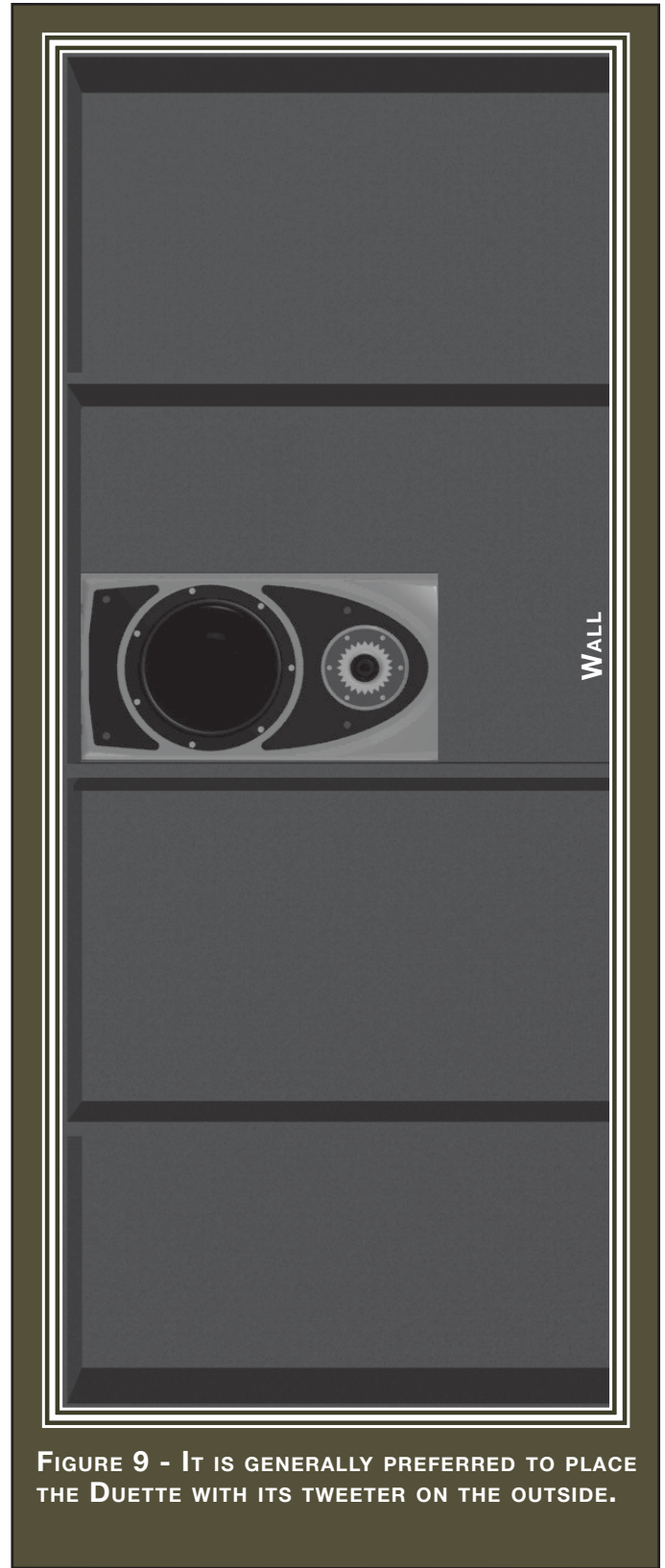

FIGURE 9 - IT IS GENERALLY PREFERRED TO PLACE THE DUETTE WITH ITS TWEETER ON THE OUTSIDE.

Wilson Audio Specialties

DUETTE

SECTION 4 - DUETTE IN A CABINET



WILSON
AUDIO

Section 4.1 – Configuring the Duette for Installation

Note: Please refer to the table below to select the appropriate tuning resistor, umbilical cable, and alignment cone options based on the height of your shelf.

CONFIGURATION CHART					
ALL CABINET INSTALLATIONS USE THE BROWN NEAR WALL UMBILICAL					
	HEIGHT				
	0" - 15"	16" - 27"	28" - 39"	40" - 50"	>50"
FRONT CONE	C	B	A	A	A
REAR CONE	A	A	A	B	C
RESISTOR	4.2	4.2	4.2	4.2	4.2

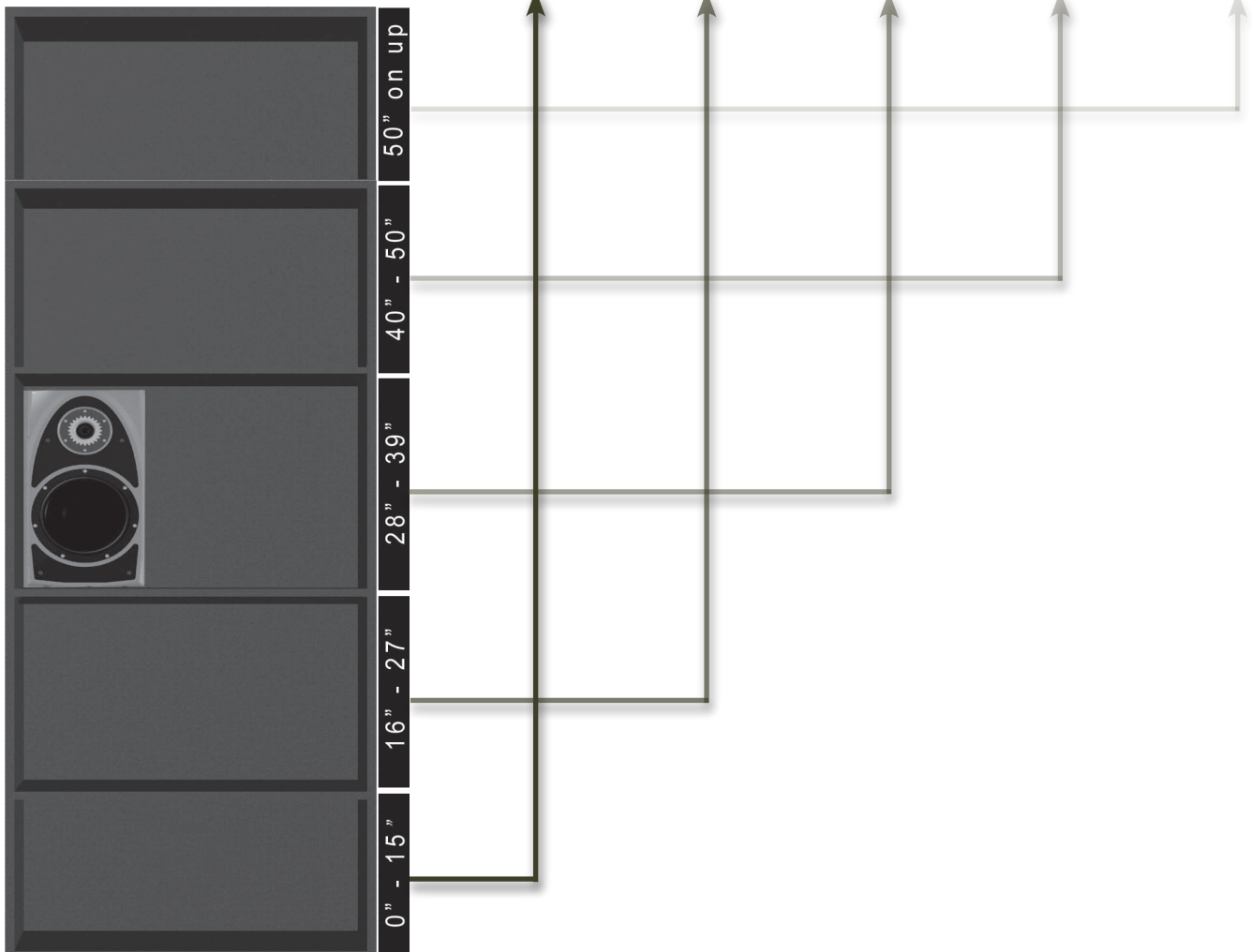

Note: The next three tables illustrate the effects of height on the frequency response of your Duette. Refer to the charts and determine which best applies to your installation. Understanding the changes in the tonal balance of the Duette at different heights will assist you in locating the optimal placement of your Duettes. It will as-

DUETTE PLACEMENT 3 TO 21 INCHES FROM THE FLOOR

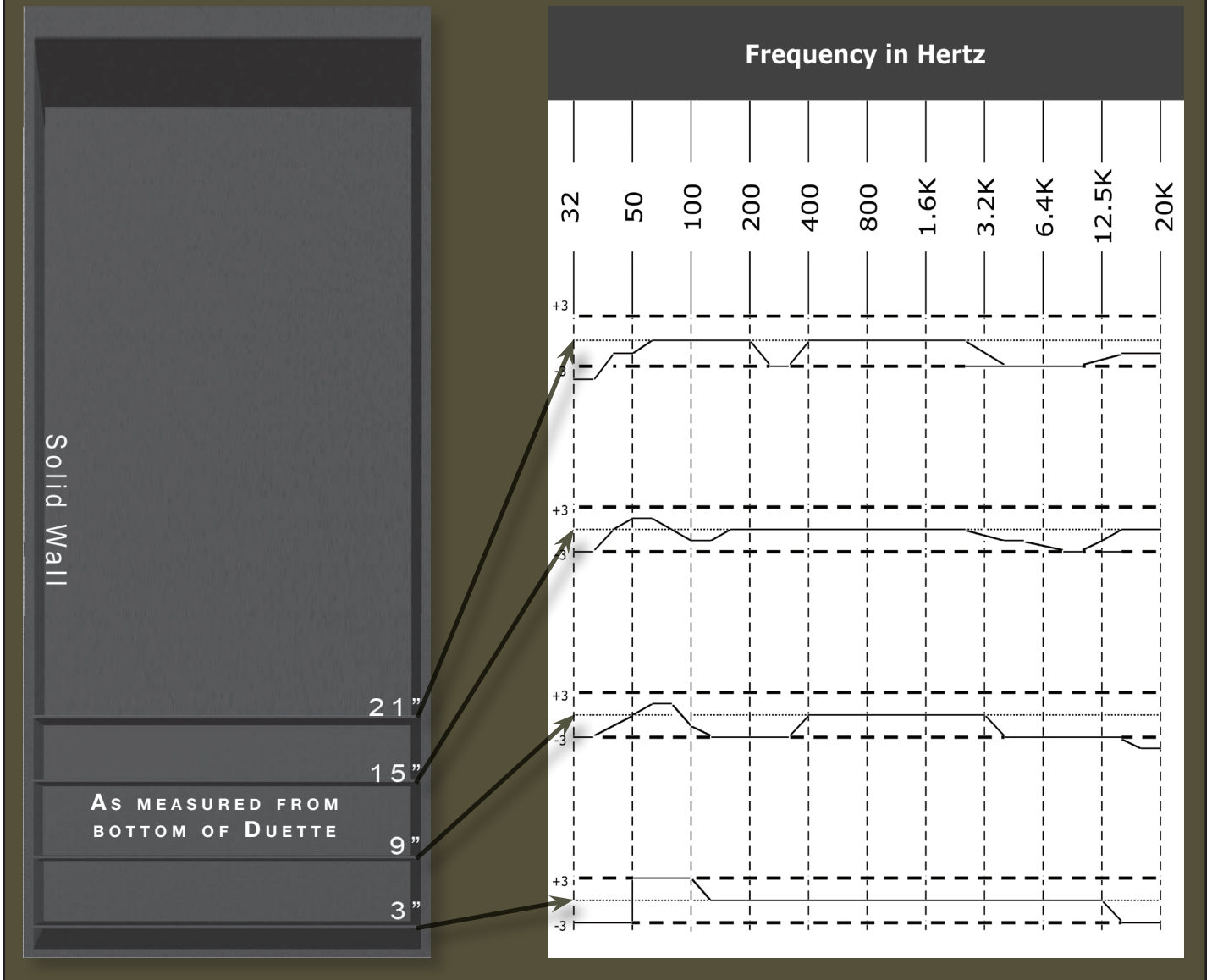

sist your efforts in optimizing Duette’s interaction with your particular room. All graphs assume the Duette is placed at least 24” from the side walls. All measurements were performed with a microphone height of 44 inches, placed on axis 8.5 feet from the loudspeakers.

DUETTE PLACEMENT 27 TO 45 INCHES FROM THE FLOOR

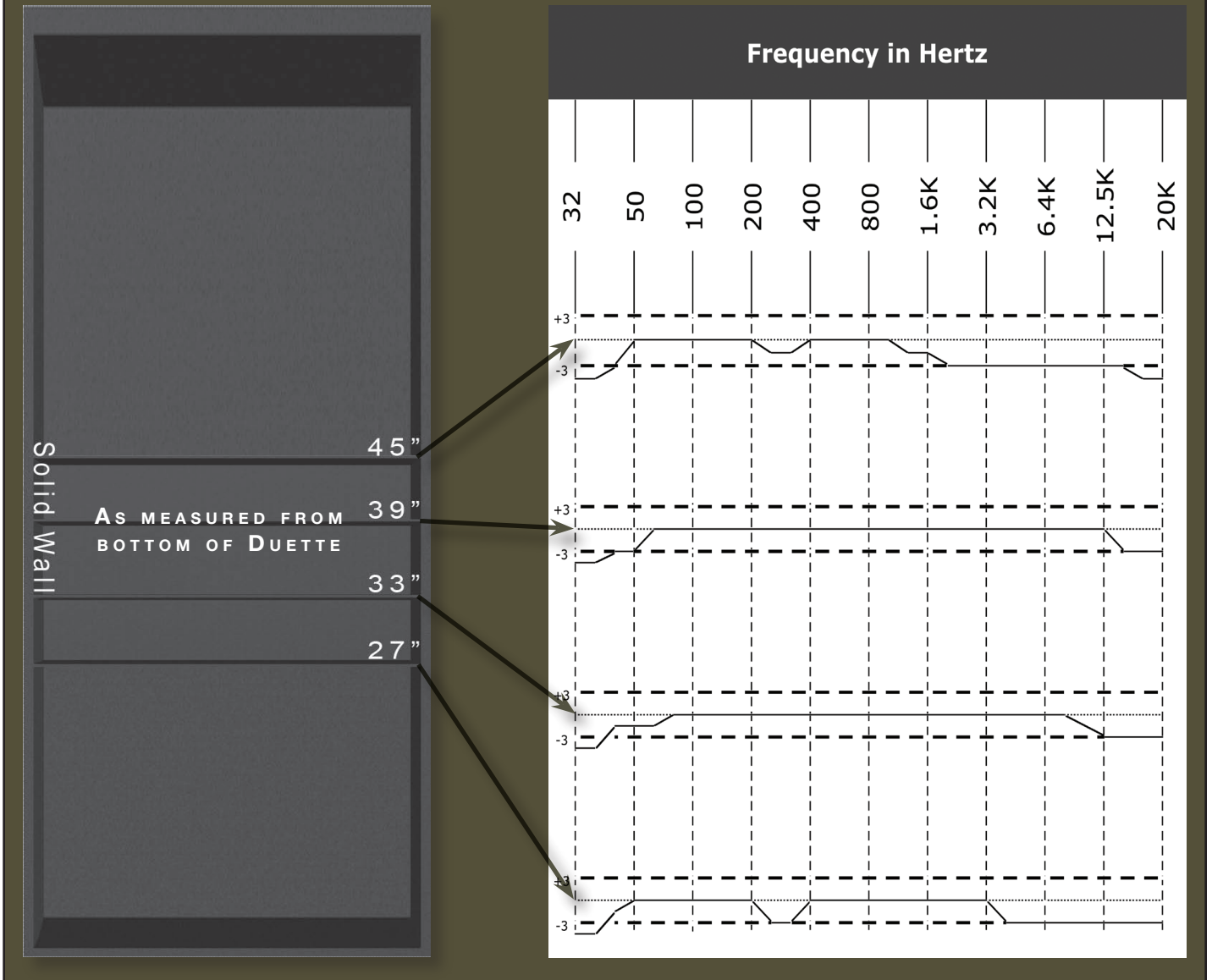

DUETTE PLACEMENT 51 TO 61 INCHES FROM THE FLOOR

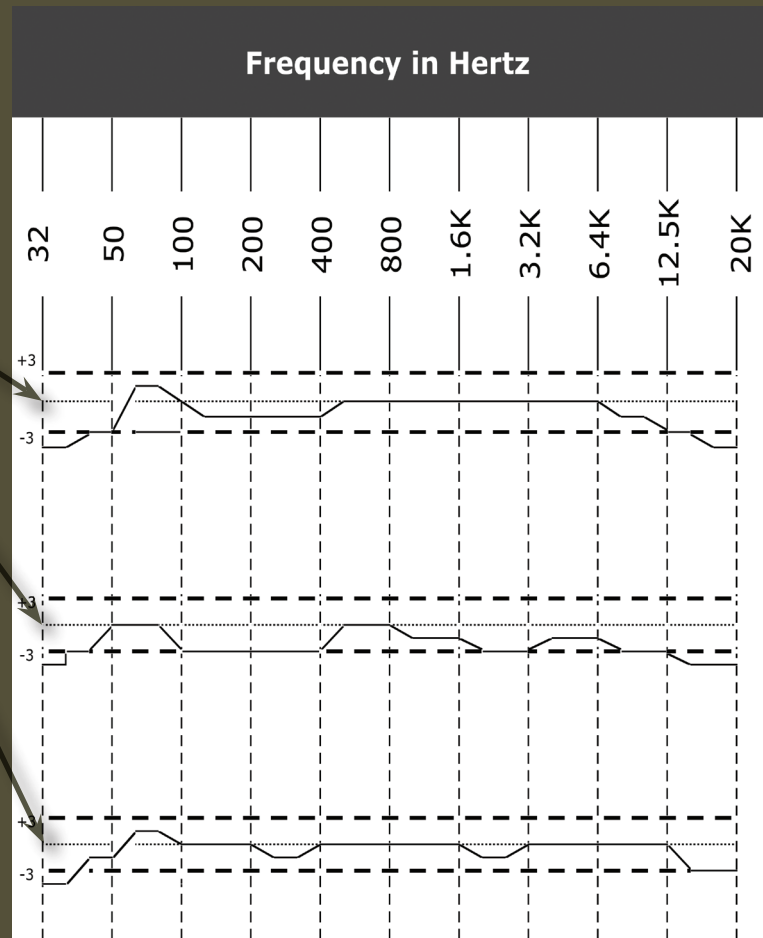
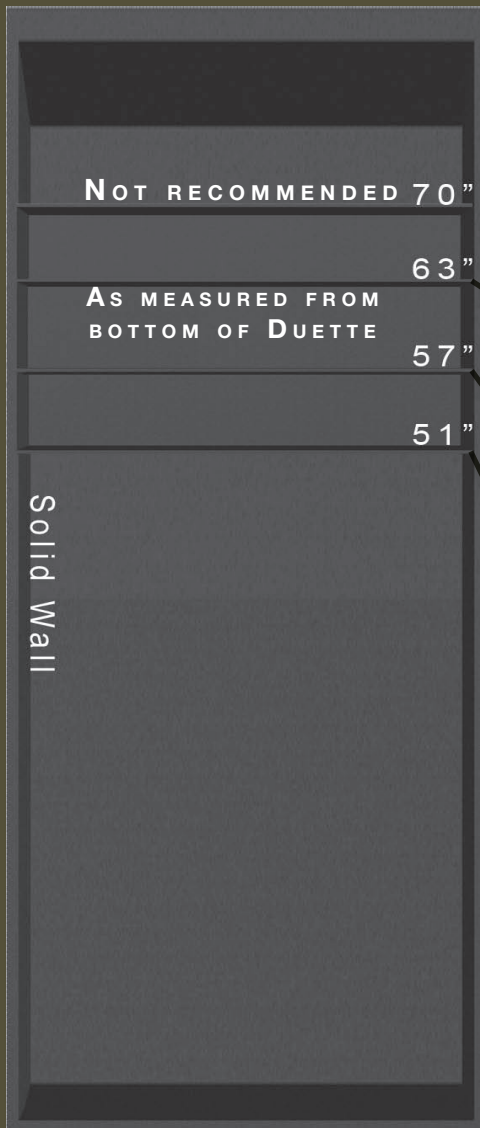

Refer to the chart below illustrating the boundary effects of the adjacent sidewall on your Duettes. Note that placement at least 18 inches from the side wall provides more linear upper bass and midrange than will placement directly next to a side wall.

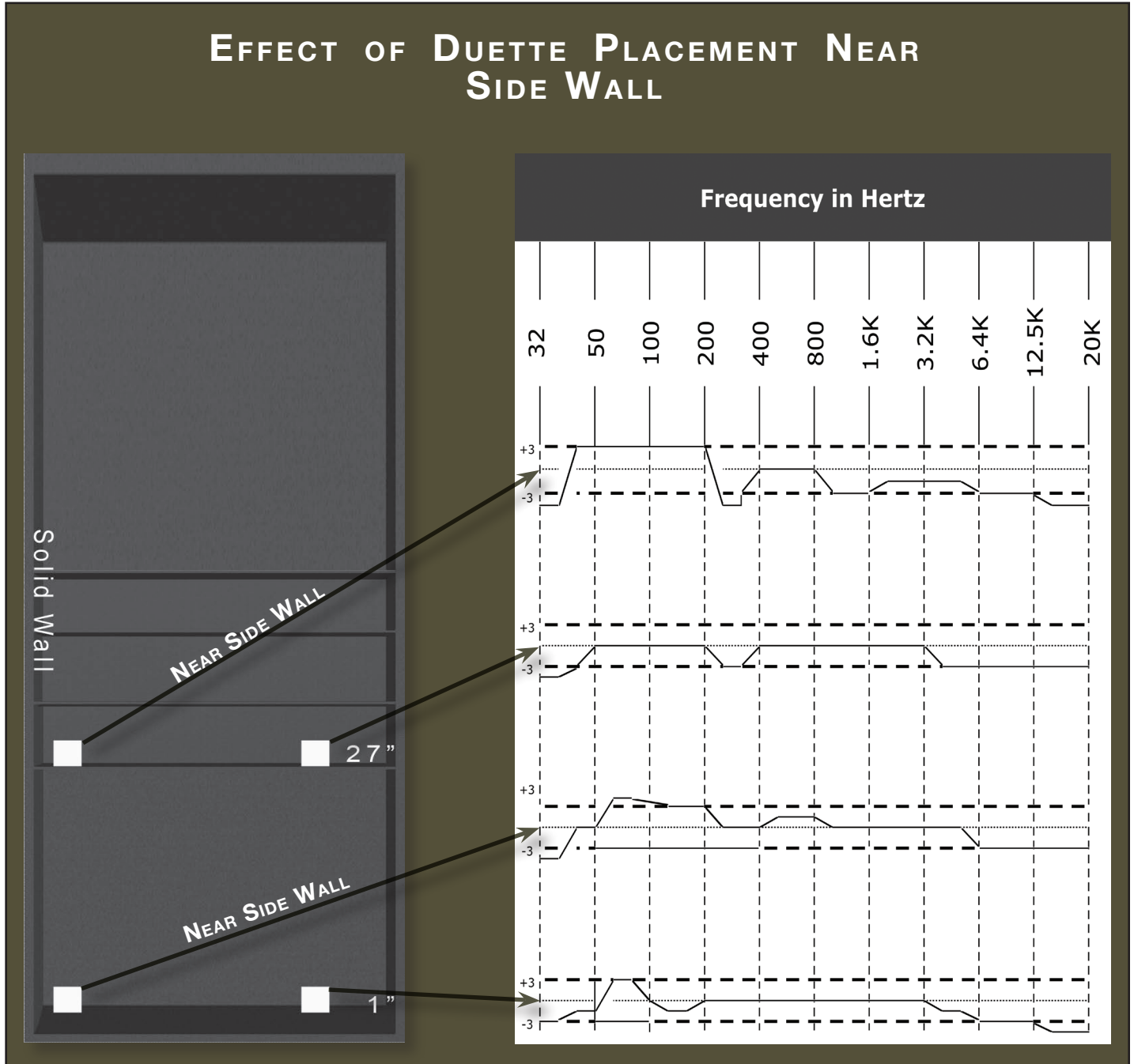

Installing the Tweeter Resistor

Note: The Duette's tuning resistor, located on the rear of the Novel crossover, is one key to optimizing the performance of your Duettes. This resistor is not installed prior to shipping and must be installed before the Duette is connected.

Locate the 4.2-ohm resistor in your Duette installation kit. Finger tighten the resistor to the top binding posts on the rear of the Novel crossover to the binding post labeled "Tweeter Resistor." Tighten the binding posts just enough so the resistor remains in place.

Locate the small Allen screw. Loosen one of the binding posts and position the metal eye of the resistor over the threaded holes. Carefully thread the Allen screw through the resistor's tab and into the threaded hole so the resistor is snug against the rear plate.

Tighten the binding posts so that they are snug. Do not over tighten as this may result in damage to the binding posts and/or the resistor

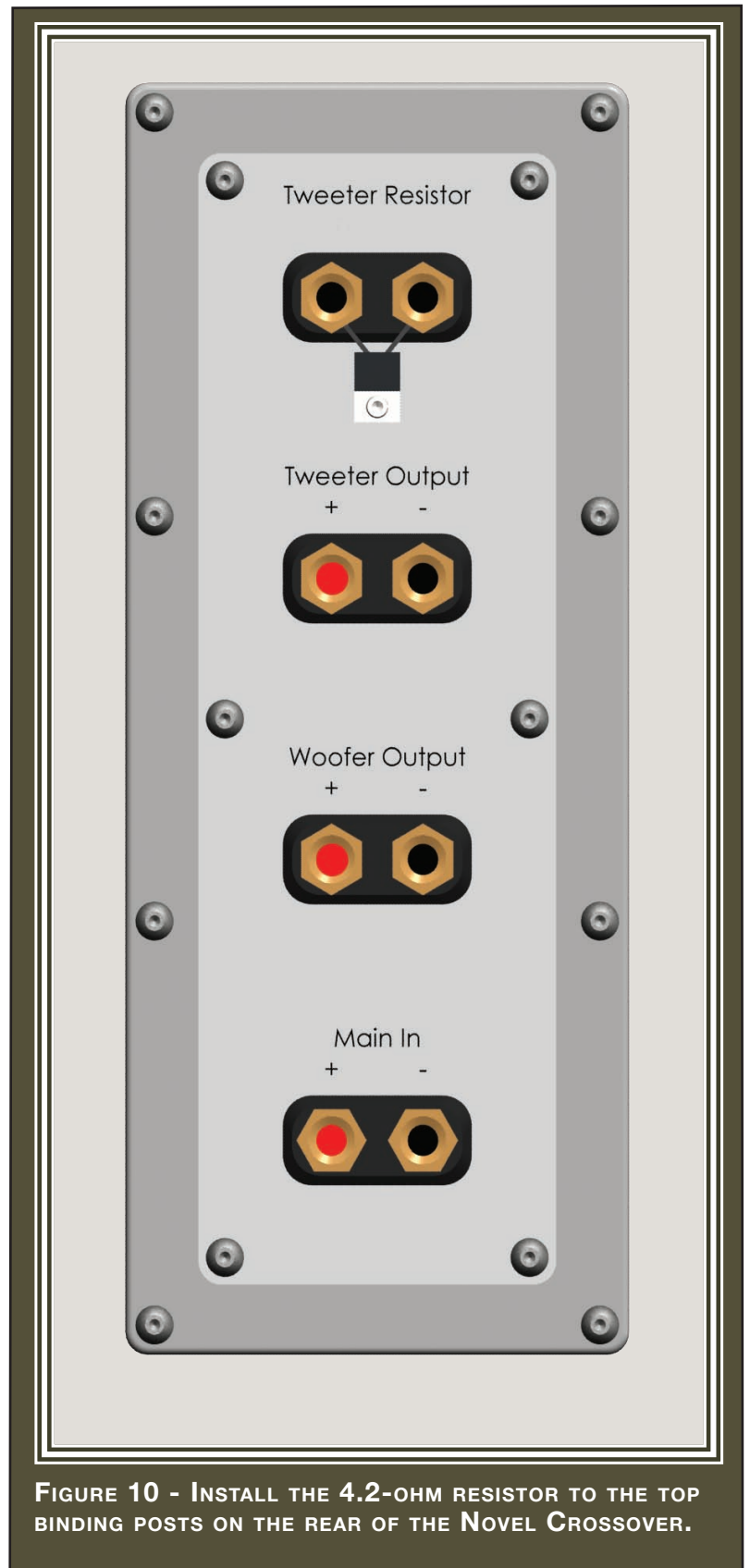

FIGURE 10 - INSTALL THE 4.2-OHM RESISTOR TO THE TOP BINDING POSTS ON THE REAR OF THE NOVEL CROSSOVER.

leads. See Figure 10.

Alignment Cones

Note: Refer to the instructions on page 49 that describe the safe procedure in removing the protective film from the Duettes. Remove the film at this time.

There are three embedded magnets, two near the front and one near the back of the Duette, located on the bottom, left, and right sides of the Duette. The magnets are embedded beneath the painted surface and are not visible (See Figure 11). This Magnepod™ (patent pending) attachment system allows the cones to be secured without additional hardware.

Your installation kit contains three cone sizes for geometric alignment tuning, labeled “A,” “B,” and “C.” The code, which reflects size, is stamped into the base of each cone. Using the above chart, determine the cone combination

that is appropriate for your installation. Remove the six cones from the installation kit.

Locate and remove the six brass discs, the round cone gaskets, and the putty from your setup kit. Prepare six pea-sized balls of the putty. Press the putty onto the center of each brass disc, compressing it to 1/4 inch (5mm) circle over the cone indent. Push the cone point into the putty until it seats in the brass disc indent. The putty will keep the cone and the brass disc together. Place the cone/disc assembly onto the bottom (or



FIGURE 11 - MAGNEPODS ARE LOCATED ON BOTH SIDES AS WELL AS THE BOTTOM OF THE DUETTE.

on the appropriate side) of your Duettes above the Magnepods. The magnetic force will center the cone in its proper location. The cones will now be attached to the Duette, secured by the Magnepods.

Remove the adhesive backing from an "O" shaped cone gasket and carefully place one over each cone. Smooth the gasket around the cone, making sure the adhesive has good contact to the bottom of the Duette. See Figure 12.

The Duette is now ready to place into the cabinet.

Note: It is important to properly install the cone gasket to prevent the Duette from sliding on its cone.

Positioning the Duette in Custom Cabinets

Wilson Audio makes available a Cabinet "rough-out" kit. This kit should be installed into the cabinet before the Duettes are installed. The Duette performance is significantly enhanced when installed in conjunction with this kit.

Refer to the above tables and graphs (pages 38-41) to gain an understanding of how Duette's performance is affected by various vertical and horizontal placements. The Duette benefits from fine tuning both side to side as well as front to back placement, within the constraints and limits of the cabinet. The Duette should be slightly



FIGURE 12 - THE CONE GASKETS ARE INSTALLED OVER THE GEOMETRIC CONES.

“toed-in” toward the listener such that from the seated position, the listener would see a small portion of the inside of each Duette enclosure.

Positioning Duette on Its Side

In a sideways position, the tweeter should be positioned such that it is at a further distance from the listener than the woofer. To accomplish this, position the Duettes with the tweeter on the outside, woofers on the inside within the stereo pair.

The tweeter end of the Duette should be positioned slightly forward relative to the woofer. The Duette is thus toed-in toward the listener. The cone setup is the same for sideways setup as for vertical. As with a vertical setup, the Duette will perform better (as shown in Figure 13) away from the side wall. See also the graph on page 41.

Cabinet Grill Cloth

Typically, grill cloth, or some other acoustically transparent covering is specified to be placed in front of cabinet-installed Duettes. Contact your Wilson Dealer to ensure the material you plan to use is acoustically

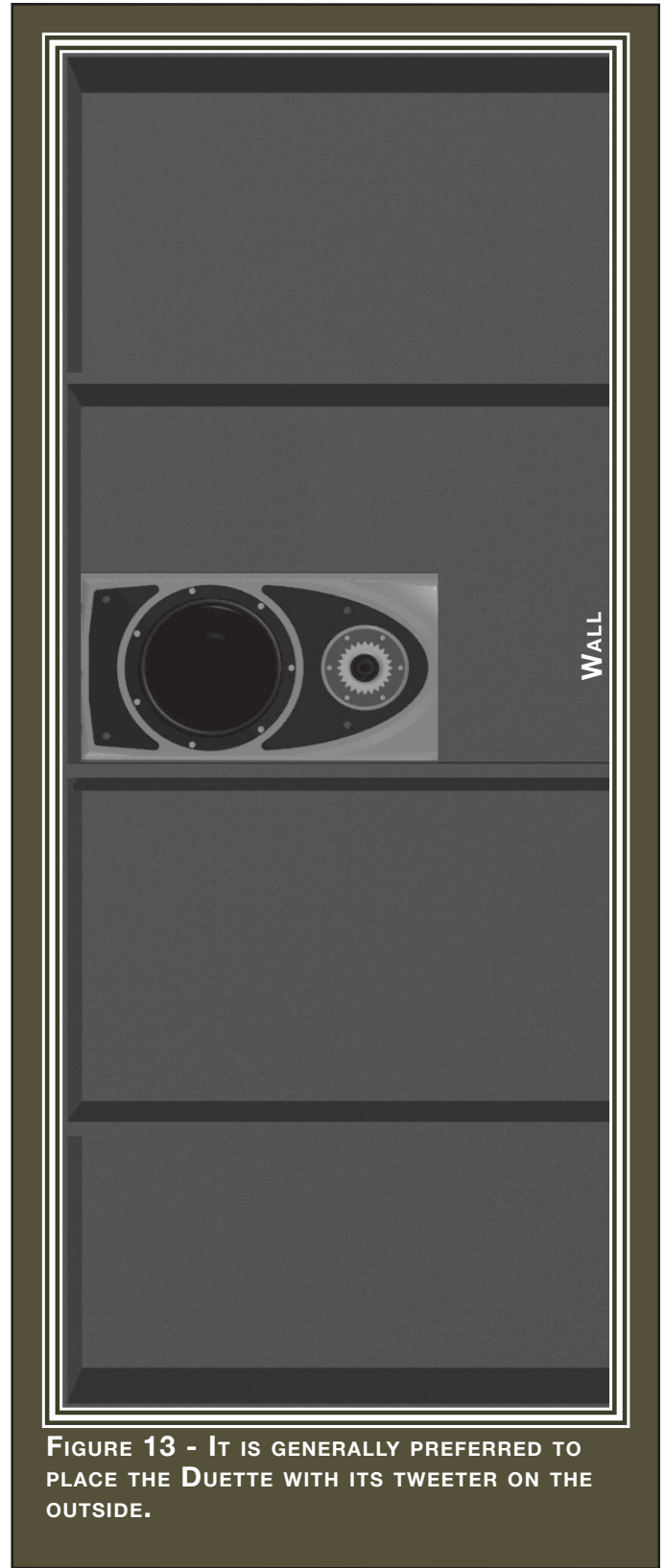

FIGURE 13 - IT IS GENERALLY PREFERRED TO PLACE THE DUETTE WITH ITS TWEETER ON THE OUTSIDE.

transparent. Some materials can introduce gross nonlinearities and greatly compromise the performance of the Duette.

Avoid lattice work or other obstructions placed in front of the Duette. Hard surfaces in front of the Duette can cause diffraction and reflective artifacts, which will change the tonal balance as well as the spacial characteristics of the sound.

SECTION 5 - CARE OF DUETTE



Section 5.0 – Care of the Finish

The Duette loudspeakers are hand painted with WilsonGloss™ paint and hand polished to a high luster. While the finish seems quite dry to the touch, final curing and complete hardening takes place over a period of several weeks.

Removing Protective Film

To protect the finish of the Duette during final manufacture, shipment, and setup in the listening room, a removable layer of protective film has been applied over the finish. It is recommended that this film be left



in place until the speakers are in their final location in the listening room. Once their final position has been determined, remove the film by following this procedure:

1. Ensure the speaker surface is room temperature before removing the protective film. Removing the protective film when the speaker surface is cold can damage the paint surface.
2. Slowly remove the film from the top down, large sections at a time, gently pulling the film downward and outward. Tearing the film aggressively can damage the paint.
3. Take care in removing the protective film near edges and corners to prevent paint damage in these areas.
4. The protective film should not be left on the painted surface for ex-

tended periods of time nor exposed to heat sources and direct sunlight.

Dusting the Duette

It is important that the delicate paint finish of the Duette be dusted carefully with the dust cloth, which has been provided. We recommend that the following procedure be observed when dusting the speakers:

- Blow off all loose dust.
- Using the special dust cloth as a brush, gently whisk off any remaining loose dust.
- Shake out the dust cloth.
- Dust the finish, using linear motions in one direction parallel to the floor. Avoid using circular or vertical motions.

Because the paint requires a period of several weeks to fully cure, we recommend that no cleaning fluids, such as glass cleaners, be used during this initial period of time. When the paint is fully cured, heavy fingerprints and other minor smudges may be removed with a glass cleaner. Always use the dust cloth. Stronger solvents are not recommended under any circumstances. Consult your dealer for further information if required. To maintain the high luster of the finish, periodic polishing may be desired. We recommend a nonabrasive carnauba-based wax and a soft cloth.

Care of the Grilles

Periodically, you will want to clean Duette's grilles. This is best done by using the round brush attachment on a vacuum cleaner hose. Gently vacuum the front surface of the grille. Be careful not to apply too much pressure. Do not use a hard plastic attachment against the grille. The grille cloth is stretched tightly over the grille frame. Too much pressure or use of a hard plastic attachment could cause the grille material to

tear, especially in the corners.

Often Wilson speaker owners desire to change the look of their listening room by changing the color of their speaker grilles. In addition to basic black, Wilson Audio offers a variety of grille colors to match most WilsonGloss finishes. Contact your local dealer for grille cloth samples or to order replacement grilles for your Duettes.

Break-in Period

All audio equipment will sound best after its components have been broken in for some period of use. Wilson Audio breaks in all woofers and mid-range drivers for approximately 12 hours. All drivers are then tested, calibrated, and matched for their acoustical properties. In your listening room, expect 25 to 50 percent of break-in to be complete after two hours of playing music at normal listening levels. Ninety percent of break-in is complete after 24 hours of playing. Playing a CD on repeat overnight can accomplish this task quickly. Wilson Audio recommends chamber music for this task.

Section 5.1 – Enclosure Technology

Materials

Wilson Audio has conducted many hours of research on the impact of materials on speaker enclosure performance. Through this effort, Wilson pioneered the use of non-resonant materials, first with the use of mineral filled acrylic in the WATT and continuing with the further development of proprietary materials for X-1 Grand SLAMM and MAXX. Even the best materials are not suited to all aspects of enclosure construction. Therefore, like all Wilson loudspeakers, the Duette is constructed of several exotic materials chosen for their specific performance attributes relevant to different portions of the enclosure.

Duette is constructed using non-resonant, high-density, composites which are then cross braced to further reduce cabinet resonance. Each of these composites meets and

exceeds the highest of ANSI test standards for its use, while offering very tight tolerances, high hardness, uniform density, and dimensional stability.

Adhesive

Wilson Audio has conducted exhaustive research into the best adhesives to permanently bond our speaker enclosures. This is often an overlooked element crucial to the proper performance of a loudspeaker. Correct modulus of elasticity, coefficient of thermal expansion, and natural frequency response are just a few of the important elements of adhesives.

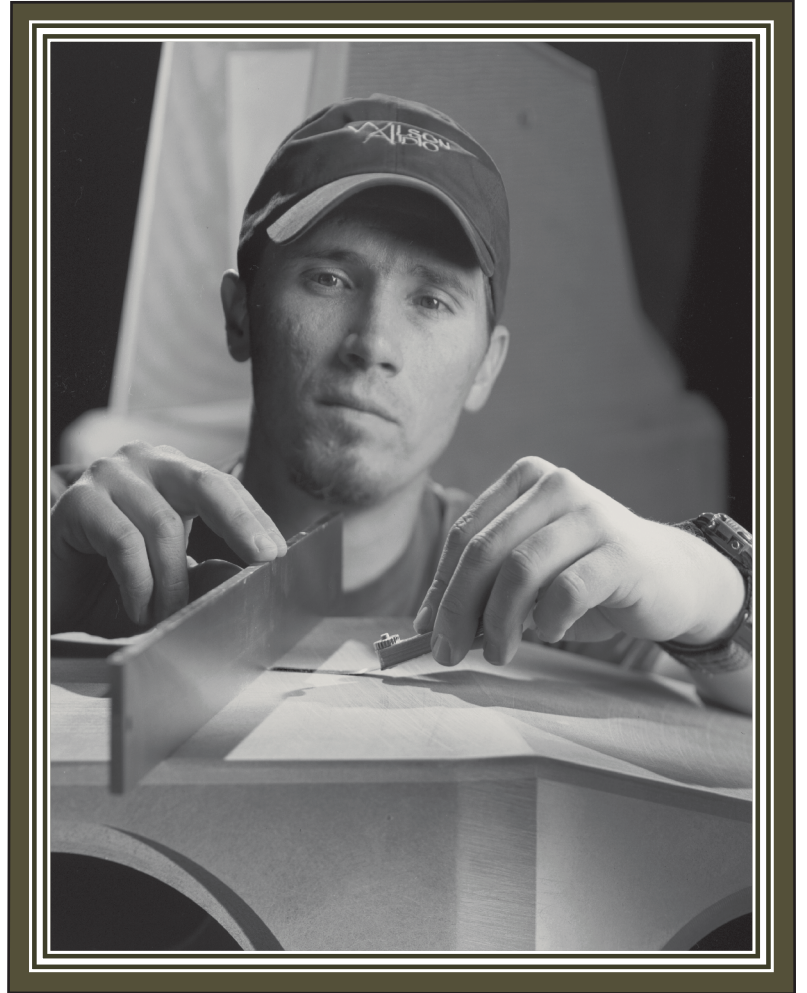

A highly cross-linked, thermo-set adhesive is used for the construction of the enclosure. It was also chosen for its excellent bond strength, solvent resistance, hardness, and optimum vibrational characteristics.

Section 5.2 – Depth of Design

Duette's compellingly authentic performance and lasting value are achieved through careful implementation of cutting edge design and engineering and then executed using the highest performance materials. Wilson Audio's use of proprietary enclosure materials and adhesives are employed to achieve truly exceptional speaker

cabinet performance. The use of these materials in Duette result in an enclosure that is inherently inert and non-resonant. All of these structural aspects are combined, allowing Wilson Audio to deliver a product that maintains the strictest structural tolerances, durability, and reliability. This also means that the Duettes will have consistent, repeatable performance, unaffected by the climatic conditions, anywhere in the world. Finally, like all Wilson products, Duette is hand-crafted with meticulous attention to detail, with an unwavering commitment to excellence. Thus, Duette will impart to her owner beauty and pleasure for many years to come.

Wilson Audio Specialties

DUETTE

SECTION 6 - IN YOUR ROOM



WILSON
AUDIO

Note: Wilson has included this section for Duettes installed on stands, away from walls.

Section 6.1 – Room Acoustics

You are surely excited about setting up your Duette loudspeakers and doing some listening, but before you begin we would like to discuss some of the important room acoustical information that will help you set up your loudspeakers properly.

Final Listening Room Setup (Voicing)

In its size and price range, the Duette is unmatched in its ability to reproduce the musical event. It is truly state of the art. However, room acoustics and boundary interactions affect the sound of a loudspeaker to such a large degree that poor setup can seriously degrade your enjoyment of even the finest loudspeaker.

Therefore, we offer the following section, which will present some guidelines on room acoustics and their interactions with loudspeakers. While we will also outline some detailed suggestions on the setup of the Duette, we strongly suggest that you have your local Wilson Audio dealer perform the final speaker “voicing” with you. Wilson dealers are specially trained in setting up Wilson loudspeakers and will ensure that you realize the full value of your purchase.

Zone of Neutrality

The “Zone of Neutrality” is an area in your room where the speakers will sound most natural. This location is where the speakers interact the least with adjacent room boundaries. It is important to have a clear working space while determining the Zone of Neutrality.

The following is a simple method to locate the Zone of Neutrality within your listening environment:

1. Stand against the wall BEHIND the location where you intend to po-

sition your Duetttes. Speaking in a moderately loud, normally pitched voice and at a constant volume, project your voice out into the room. Your voice will have an overly heavy, “chesty” quality because of your proximity to the rear wall.

2. While speaking, slowly move out into the room, progressing in a direction parallel to the sidewall. It is helpful to have another listener seated in the listening position to assist you during this process. Listen to how your voice “frees up” from the added bass energy imparted by the rear wall boundary. Also notice that your voice is quite spatially diffuse (to your assistant, your voice will sound spatially large and difficult to localize) as you begin to ease away from the rear wall.

3. At some point during your progression forward into the room, you will observe a sonic transition in your voice; it will sound more tonally correct and less spatially diffuse (your assistant can now precisely localize the exact origin of your voice). When you hear this transition, you have entered the inner edge of the Zone of Neutrality. Place a piece of tape on the floor to mark this location. Although it will vary from room to room, the zone in most rooms begins between two and a half to three feet from the rear wall.

4. Continue to walk slowly away from the rear wall. After some distance, usually one to two feet past the first piece of tape, you will begin to hear your voice lose focus and appear to reflect (echo) in front of you. This is caused by the return of the room’s boundary contribution; your voice is now interacting with the opposite wall. At the point where you begin to hear the reflected sound of your voice, you have reached the inner edge of the Zone of Neutrality. Place a piece of tape on the floor and mark this location. The distance between the “inner” and “outer” edge tape marks is usually between eight inches (for small, interactive rooms) and three feet (for large, more neutral rooms).

5. Now position yourself against the side wall perpendicular to the intended speaker location. Stand between the two tape marks. Using the same procedure as above, begin moving into the room toward the op-

posite sidewall, progressing between the two pieces of tape. As above, listen for the point in the room where your voice transitions from bass-heavy and diffuse to neutral. Mark this point with tape. Continue your progression until there is an obvious interaction with the opposite wall in front of you and mark this point with tape. The four pieces of tape now form a rectangle that establishes the Zone of Neutrality for the loudspeaker located on that side of the room. Using the four marks as your guide, tape an outline to define the boundaries of the rectangle.

6. Repeat this process for each speaker location individually. These are your Zones of Neutrality, one for each channel.

Theoretically, the Zone of Neutrality for any room runs like a path, parallel to the walls all around the room. Adjacent to very large windows and open doors, the outer edge of the Zone of Neutrality moves closer to the wall and becomes wider. If you were to extend the inner and outer boundaries of the Zone for the sidewalls and the front wall (behind the speakers), they would intersect. After you complete this procedure for the other loudspeaker, you will now have two rectangles, one on the floor on either side of the room.

Section 6.2 – Room Reflections

Slap Echo

Probably the most obnoxious form of reflection is called “slap echo.” With slap-echo, primarily midrange and high frequency sounds reflect off of two parallel hard surfaces. The sound literally reverberates back and forth until it is finally dissipated over time. You can test for slap echo in any room by clapping your hands sharply in the middle of the room and listening for the characteristic sound of the echo in the midrange. Slap echo destroys the sound quality of a stereo system in two ways:

- It adds harshness to the upper midrange and treble by storing time-domain smearing energy.

- It destroys the delicate phase relationships, which help to establish an accurate sound stage.

Slap echo is a common acoustical problem in the typical domestic listening room because most of these rooms have walls with a hard, reflective nature, only occasionally interrupted by curtains, wall art, or drapes. The best (but least practical) solution to eliminate slap echo is nonparallel walls. This is because, rather than support slap-echo, nonparallel walls allow the sound to diffuse. This approach can be accounted for during the construction process. For existing rooms, slap echo can also be controlled entirely by the application of absorptive materials to the hard surfaces. These are absorptive materials that can be used to ameliorate slap echo:

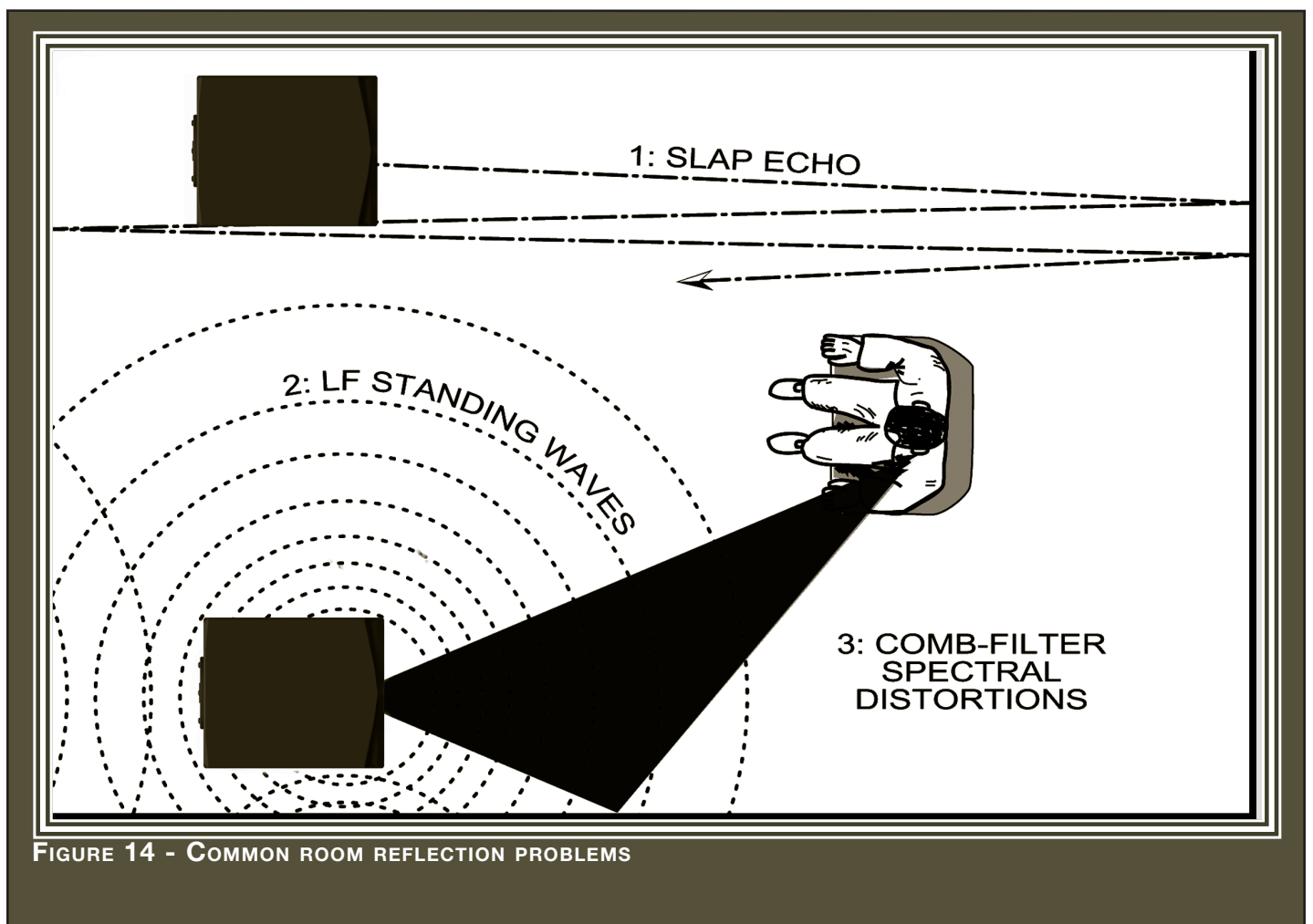

FIGURE 14 - COMMON ROOM REFLECTION PROBLEMS

- Illbruck Sonex®
- Air duct board
- Cork panels
- Large ceiling to floor drapes
- Carpeting to wall surfaces

In many domestic listening environments, heavy stuffed furnishings reduce slap echo somewhat. Unfortunately, their effectiveness is not predictable. Diffusers are sometimes also used to very good subjective effect, particularly in quite large rooms. Sound absorbent materials such as described above will alter the tonal characteristic of the room by making it sound “deader,” less “bright and alive,” and “quieter.” Soundtrack effects will be more localized. However, over-damping the room can render reproduced sound that is lacking in musical involvement and “aliveness.”

Diffusers, on the other hand, do not affect the tonal balance characteristic of the room as much. Placed properly, diffusers create a smoother and more open sound. Some diffusers, due to their construction, create narrow midrange peaks and suck-out the warmth region. Do not use diffusers on the wall behind the speakers or on the sidewalls directly beside the speakers. It is our experience that all of these room treatment devices should be used judiciously.

Standing Waves

Another type of reflection phenomenon is “standing waves.” Standing waves cause the unnatural boosting or accentuation of certain frequencies, typically in the bass, to be found at certain discreet locations in the room. These locations differ according to room dimension and size. A room generating severe standing waves creates difficulty in setup. In these rooms, the speaker will sound radically different as it is

moved around. The effects of standing waves on a loudspeaker's performance are primarily in the areas listed.

- Tonal balance
- Resolution of low-level detail
- Soundstaging

Standing waves are more difficult to correct than slap echo because they tend to occur at a lower frequency. Absorbent materials, such as Illbruck Sonex, are ineffective at controlling reflections in the bass region. Moving speakers about slightly in the room is, for most people, their only control over standing waves. Sometimes a change of placement of as little as two or three inches can dramatically alter the tonal balance of a small system. Fortunately, minor low frequency standing waves are well controlled by positioning ASC Tube Traps™ in the corners of the room. Very serious low frequency accentuation usually requires a custom-designed bass trap system.

Low frequency standing waves can be particularly troublesome in rooms constructed of concrete or brick. These materials trap the bass in the room unless it is allowed to leak out of the room through windows and doors.

In general, placement of the speaker in a corner will excite the maximal number of standing waves in a room and is to be avoided for most direct radiator, full-range loudspeaker systems. Some benefit is achieved by placing the stereo pair of loudspeakers slightly asymmetrically in the listening room. This is so the standing waves caused by the distance between one speaker and its adjacent walls and floors are not the same as the standing wave frequencies excited by the dimensions in the other channel.

Comb Filter Effect

The comb filter effect is a special type of standing wave noticeable primarily at higher frequencies and shorter wavelengths.

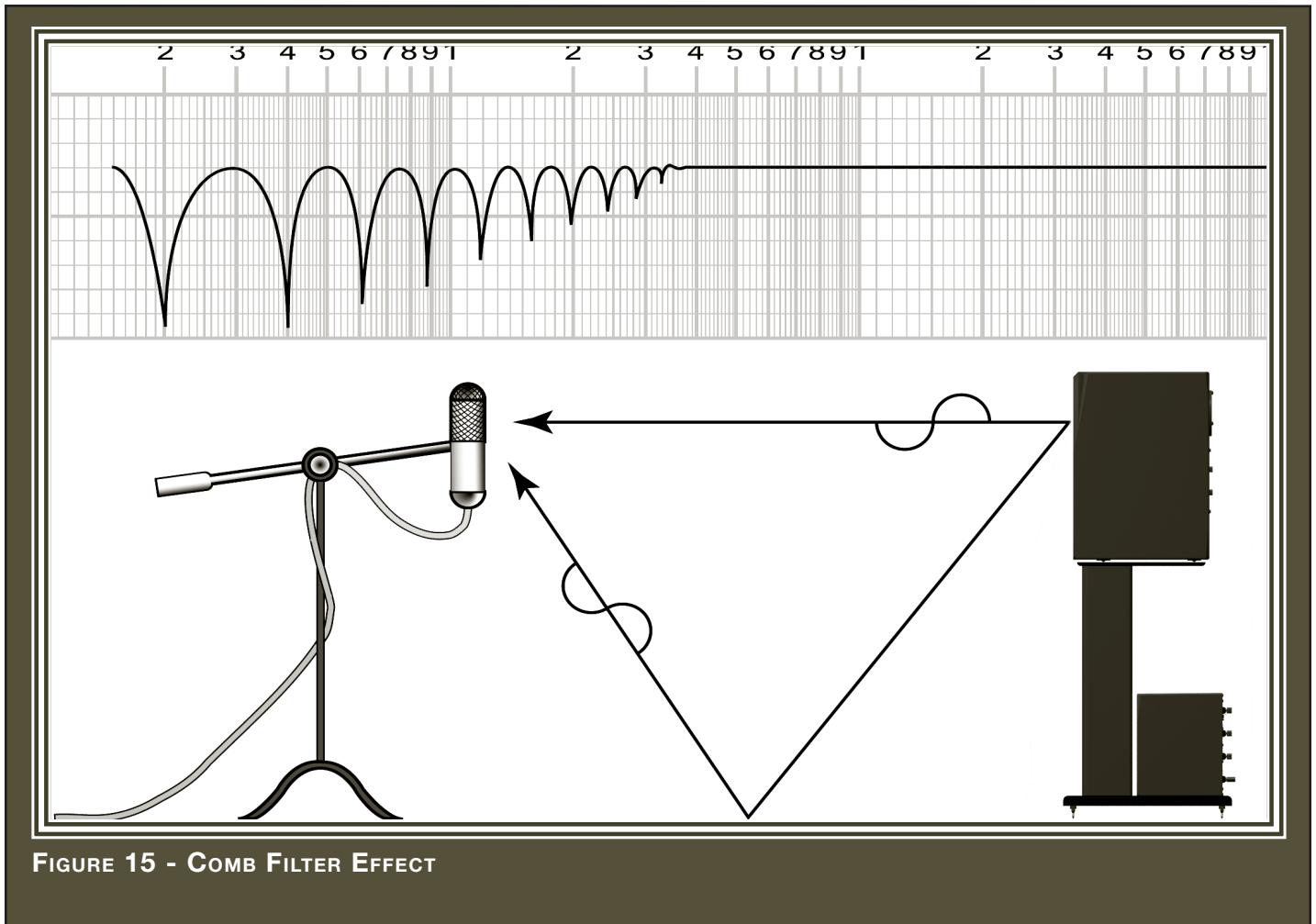

Acoustical comb filtering occurs when sound from a single source, such as a loudspeaker, is directed toward a microphone or listener from a distance. The first sound to reach the microphone is the direct sound, followed by a delayed, reflected sound. At certain frequencies, cancellation occurs because the reflected sound lags in phase relative to the direct sound. This cancellation is most apparent where the two frequencies are 180 degrees out of phase. Further, there is augmentation at other frequencies where the direct and the reflected sounds arrive in phase. Because it is a function of wavelength, the comb filter effect will notch out portions of the audio spectrum at regularly-spaced intervals. Subjectively, comb filter effect evidences itself as follows:

- Added roughness to the sound.

- Reduction of harmonic richness.
- Smearing of lateral soundstage image focus and placement.

Section 6.3 – Resonances

Resonance in listening rooms is generally caused by two sources:

- Structures within the listening room.
- The volume of air itself within the listening room.

Structural Resonance

Structural resonances are familiar to most people as buzzes and rattles, but this type of resonance usually only occurs at extremely high volume levels and is usually masked by the music. In many wood frame rooms the most common type of structural resonance problem is “booming” of walls and floors. You can test for these very easily by tapping the wall with the palm of your hand or stomping on the floor. Most rooms exhibit mid-bass “boom” when struck. The loudspeaker playing in the room also excites these resonances. To give you an idea of what the perfect wall would sound like, imagine rapping your hand against the side of a mountain. Structural wall resonances generally occur in the low to mid-bass frequencies and add a false fullness to the tonal balance. They, too, are more prominent at louder levels, but their contribution to the sound of the speaker is more progressive. Rattling windows, picture frames, lamp shades, etc., can generally be silenced with small pieces of caulk or with blocks of felt. However, short of actually adding additional layers of sheet rock to flimsy walls, there is little that can be done to eliminate wall resonances.

Air Volume Resonance

The physical dimensions and volume of air in a room will also support standing

wave modes and resonances at a frequencies determined by the size of the room. Larger rooms will resonate at a lower frequency and have more complex (better) modal distributions than will smaller rooms. Air volume resonances, wall panel resonances, and low frequency standing waves, together, combine to form a low frequency coloration in the sound. At its worst, it is a grossly exaggerated fullness, which tends to obscure detail and distort the natural tonal balance of the speaker system. Occasionally, however, there is just enough resonance to give a little added warmth to the sound, an addition some listeners prefer. Careful placement of loudspeakers in the room can dramatically reduce the speakers' destructive interaction with low frequency modes. ASC Tube Traps™ have been found to be effective in reducing some of these low frequency room colorations. Custom designed and constructed bass traps, such as perforated Helmholtz resonators, provide the greatest degree of low frequency control.

Section 6.4 – Your Room

Room Shapes

Standing waves are pressure waves propagated by the interaction of sound and opposing parallel walls. This interaction creates patterns of low and high acoustical pressure zones that accentuate and attenuate particular frequencies. Those frequencies are dependent on room size and dimension.

There are three basic shapes for most rooms: square, rectangular, and L-shaped (see Figure 16).

A perfectly square room is the most difficult room in which to set up speakers. By virtue of its shape, a square room is the perfect medium for building and sustaining standing waves. These rooms heavily influence the music played by loudspeakers, greatly diminishing the listening experience.

Long, narrow, rectangular rooms also pose their own special acoustical problems

for speaker setup. They have the ability to create several standing wave nodes, which will have different standing wave frequency exaggerations depending on where you are sitting. Additionally, these long rooms are often quite lean in the bass near the center of the room. Rectangular rooms are still preferred to square rooms because, by having two sets of dissimilar length walls, standing waves are not as strongly reinforced and will dissipate more quickly than in a square room. In these rooms, the preferred speaker position for spatial placement and midrange resolution would be on the longer walls. Bass response would be reinforced by speaker placement on the short walls.

In many cases, L-shaped rooms offer the best environment for speaker setup. Ideally, speakers should be set up along the primary (longest) leg of the room. They should fire from the end of the leg (short wall) toward the L, or they should be along the longest wall. In this way, both speakers are firing the same distance to the back wall. The asymmetry of the walls in L-shaped rooms resists the buildup of standing waves (see Figure 16).

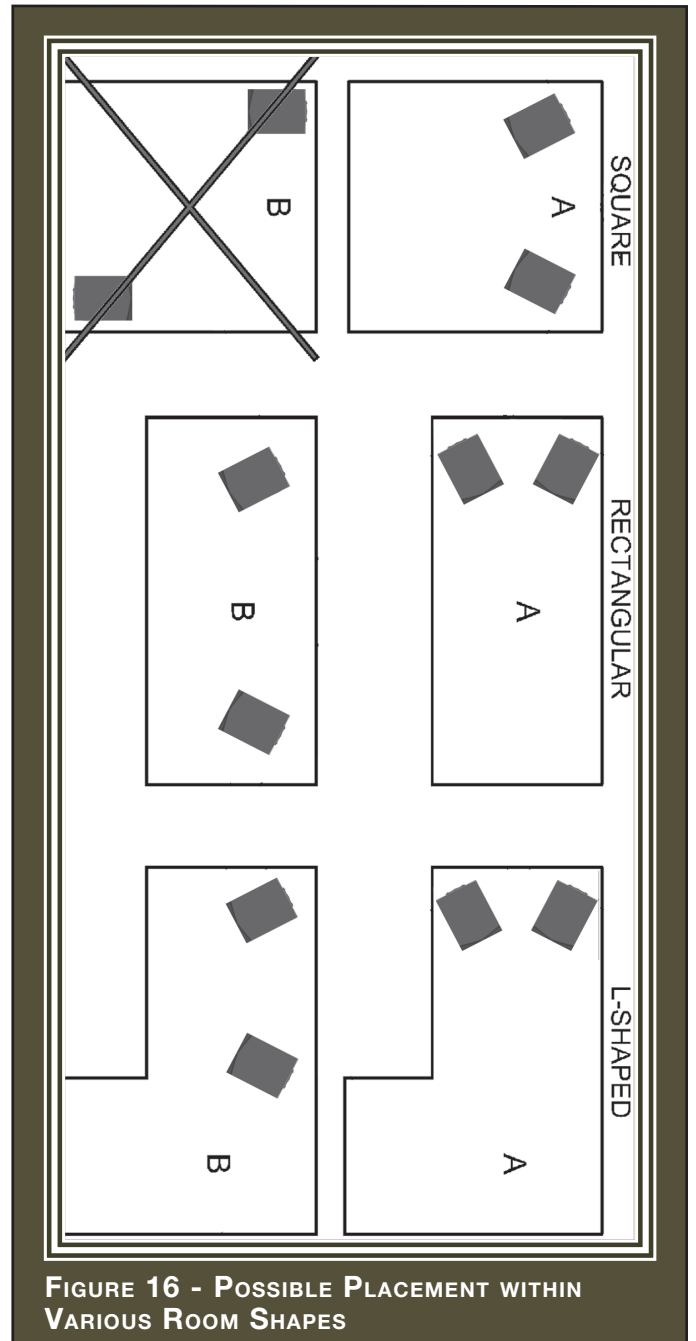

FIGURE 16 - POSSIBLE PLACEMENT WITHIN VARIOUS ROOM SHAPES

Duette In A Dedicated Home Theater

Home theaters can be organized many different ways. Some use rows of couches. Others use rows of multiple chairs.

In addition to watching movies, most users want to listen to two-channel music at the highest quality possible. It is desirable, therefore, to choose a single optimum seating position in a home theater and build the rest of the seating positions around this position.

If your optimum position is located on a couch, you should center the loudspeakers on the center position of the couch.

If the seating area consists of multiple rows of chairs, the second row should be optimized for the best sound quality. Odd numbers of chairs arranged in rows work best as this will allow a single chair to be positioned in the center. This approach will also provide the best overall sound for the greatest number of seats.

Speaker Placement Versus Listening Position

The location of your listening position is as important as the careful setup of your Duetto speakers. Ideally, the listening distance from the speaker (measured to the front of the loudspeaker) should be no more than 1.1 to 1.25 times the distance between the tweeters on each speaker. Therefore, in a long, rectangular room of 12' x 18', if the speaker tweeters are going to be 9' apart, you should be sitting 9'11" to 11'3" from the speaker. This would be more than halfway down the long axis of the room.

Many people place the speakers on one end and sit at the other end of the room. This approach will not yield the finest sound. Carefully consider your listening position. Our experience has shown that any listening position that places your head closer than 14" from a room boundary will diminish the sonic results of your listening.

Decide where you want your favorite listening position to be. Please remember that your Duettes will fill almost any room with the most beautiful sound available. If you take care in placing your new speakers, you will optimize the Duetto's perfor-

mance in your room.

Speaker Orientation

The Duette is designed for maximum phase coherence and pulse replication accuracy when each speaker is aimed directly at the listener or microphone. Thus, your Duette should be “toed-in.” In other words, the listener, when seated in the listening position looking forward with his/her head in a rested position, should just barely see the surface of the inner side of each Duette. Toeing in the speakers provides meaningful improvements in resolution of low-level detail in the midrange as well as appreciable improvements in sound staging performance.

Summary

In summary, for optimal tonal balance accuracy, resolution of low level detail, and soundstaging performance, the Duette should be positioned as outlined in this section. Ideally, the speakers should not be positioned too far from the listener if maximum resolution of low-level detail is required. If possible, the speakers should be positioned out into the room, slightly asymmetrically vis a vis the side and rear walls. The speakers should be “toed-in” toward the listener, preferably so that the listener, at his seated position, can barely see the surface of the inner side of the Duette as he/she faces the speaker. It is recommended that a distance of two to three feet, and possibly more, be maintained between the Duette and the rear walls and that a distance of at least two feet be maintained between the front panel of the Duette and reflective side walls. Depending on the room, judicious use of sound absorbent materials will reduce the space requirement.

By following the guidelines in this manual, your new Duette loudspeakers can provide you with a lifetime of pure music reproduction.

SECTION 7 - SYSTEM SPECIFICATIONS



Enclosure Type:	Rear Ported Woofer/Midrange Enclosed Tweeter
Woofers/Midrange:	1 - 8 inch
Tweeter:	1 - 1 inch soft dome
Sensitivity:	89 dB@ 1 watt (2.83V at meter)
Nominal Impedance:	4 ohms, 3 ohms minimal
Minimum Amplifier Power:	7 Watts per channel
Frequency Response	36 Hz - 32.5 kHz (boundary dependent)
Overall Dimensions	Height: 18 13/32 inches Width: 9 3/8 inches Depth: 13 3/4 inches
Duette Weight Per Channel:	40 lbs each
Novel Crossover Dimensions	Height: 9 3/4 inches Width: 4 1/8 inches Depth: 10 3/16 inches
Duette Weight Per Channel:	19 lbs each
System Shipping Weight (approx.):	210 lbs

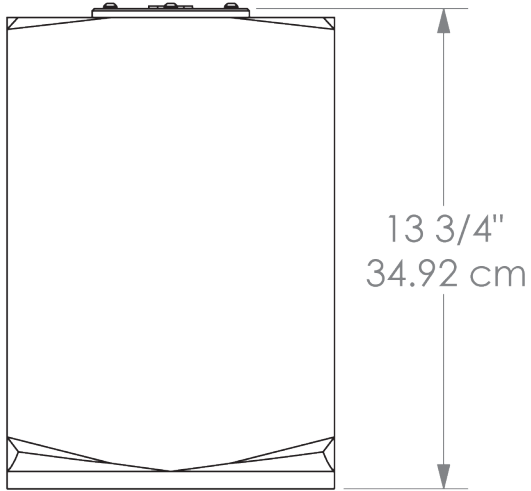

Duette Dimensions

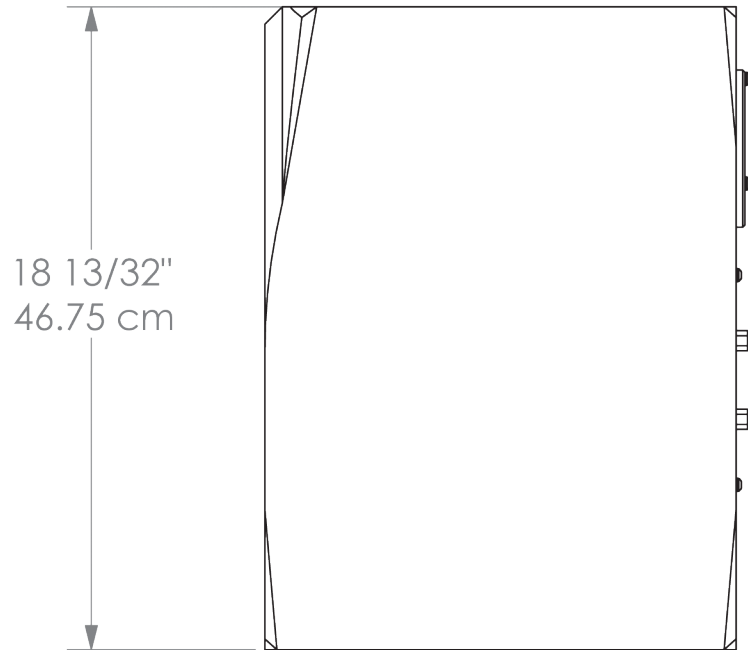
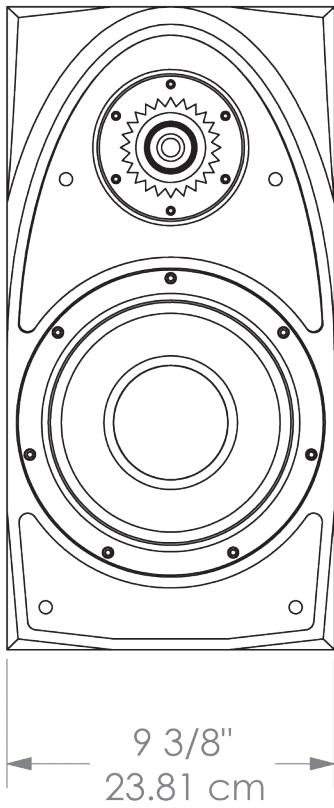

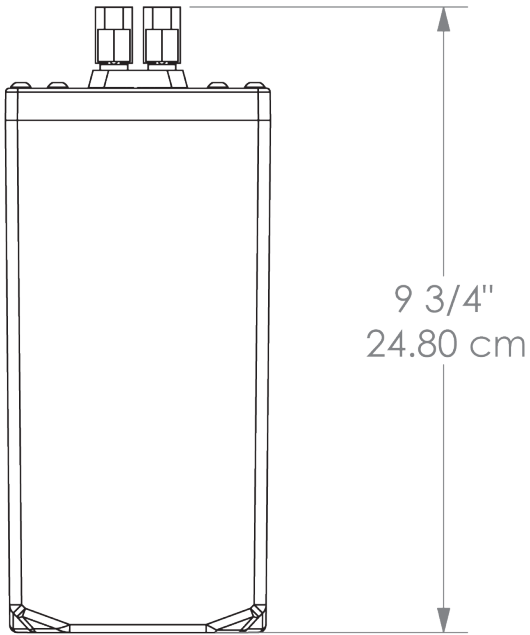

Novel Dimensions

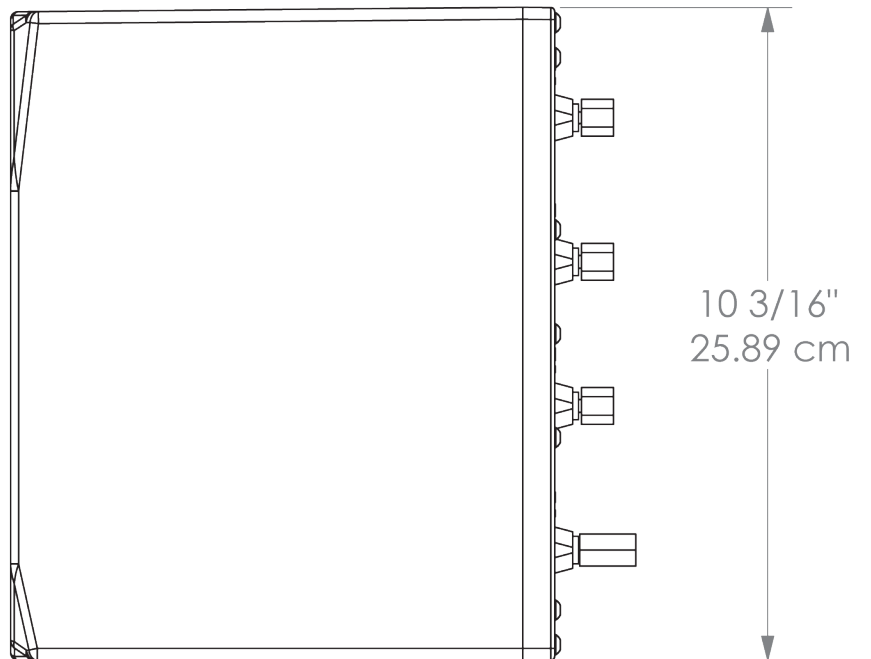
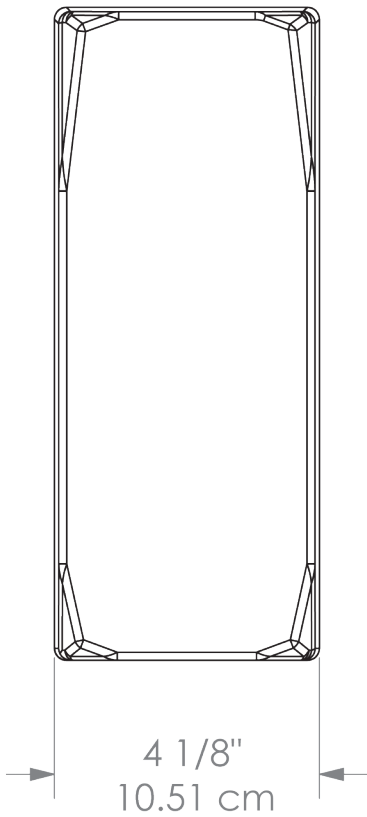

Wilson Audio Specialties

SECTION 8 - WARRANTY INFORMATION

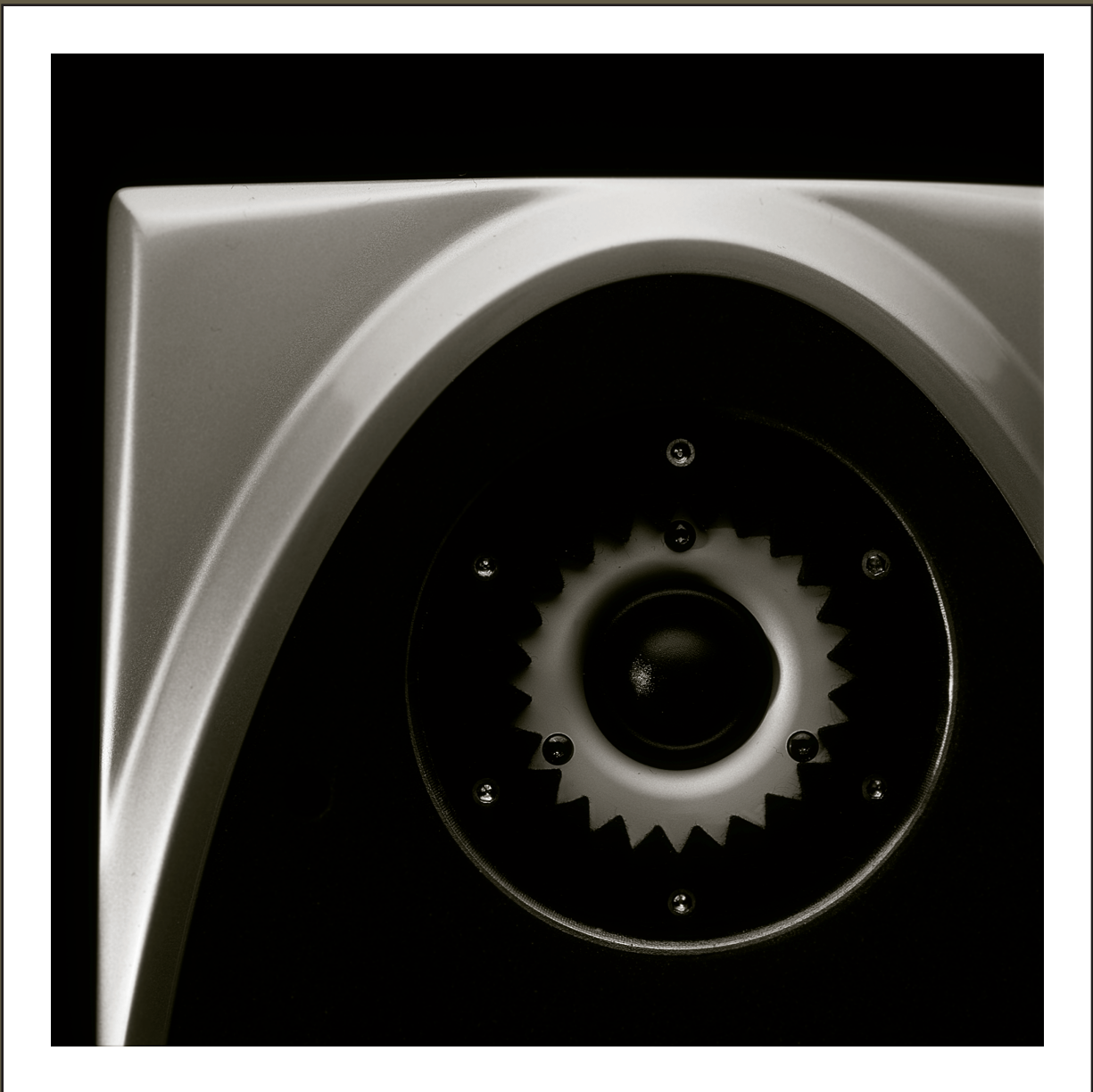

Section 8.0 - Warranty Information

Limited Warranty

Subject to the conditions set forth herein, Wilson Audio warrants its loudspeakers to be free of manufacturing defects in material and workmanship for the Warranty Period. The Warranty Period is a period of 90 days from the date of purchase by the original purchaser, or if both of the following two requirements are met, the Warranty Period is a period of five (5) years from the date of purchase by the original purchaser:

Requirement No. 1. No later than 30 days after product delivery to the customer, the customer must have returned the Warranty Registration Form to Wilson Audio;

Requirement No. 2. The product must have been professionally installed by the Wilson Audio dealer that sold the product to the customer.

FAILURE TO COMPLY WITH EITHER REQUIREMENT NO. 1 OR REQUIREMENT NO. 2 WILL RESULT IN THE WARRANTY PERIOD BEING LIMITED TO A PERIOD OF 90 DAYS ONLY.

Conditions

This Limited Warranty is also subject to the following conditions and limitations. The Limited Warranty is void and inapplicable if the product has been used or handled other than in accordance with the instructions in the owner's manual, or has been abused or misused, damaged by accident or neglect or in being transported, or if the product has been tampered with or service or repair of the product has been attempted or performed by anyone other than Wilson Audio, an authorized Wilson Audio Dealer Technician or a service or repair center authorized by Wilson Audio to service or repair the product. Contact Wilson Audio at (801) 377-2233 for information on location of Wilson Audio Dealers and authorized service and repair centers. Most repairs can

be made in the field. In instances where return to Wilson Audio's factory is required, the dealer or customer must first obtain a return authorization. Purchaser must pay for shipping to Wilson Audio, and Wilson Audio will pay for shipping of its choice to return the product to purchaser. **A RETURNED PRODUCT MUST BE ACCOMPANIED BY A WRITTEN DESCRIPTION OF THE DEFECT.** Wilson Audio reserves the right to modify the design of any product without obligation to purchasers of previously manufactured products and to change the prices or specifications of any product without notice or obligation to any person.

Remedy

In the event that the product fails to meet the above Limited Warranty and the conditions set forth herein have been met, the purchaser's sole remedy under this Limited Warranty shall be to: (1) contact an authorized Wilson Audio Dealer within the Warranty Period for service or repair of the product without charge for parts or labor, which service or repair, at the Dealer's option, shall take place either at the location where the product is installed or at the Dealer's place of business; or (2) if purchaser has timely sought service or repair and the product cannot be serviced or repaired by the Dealer, then purchaser may obtain a return authorization from Wilson Audio and at purchaser's expense return the product to Wilson Audio where the defect will be rectified without charge for parts or labor.

Warranty Limited to Original Purchaser

This Limited Warranty is for the sole benefit of the original purchaser of the covered product and shall not be transferred to a subsequent purchaser of the product, unless the product is purchased by the subsequent purchaser from an authorized Wilson Audio Dealer who has certified the product in accordance with Wilson Audio standards and requirements and the certification has been accepted by Wilson Audio, in which

event the Limited Warranty for the product so purchased and certified shall expire at the end of the original Warranty Period applicable to the product.

Demonstration Equipment

Equipment, while used by an authorized dealer for demonstration purposes, is warranted to be free of manufacturing defects in materials and workmanship for a period of five (5) years from the date of shipment to the dealer. Demo equipment needing warranty service may be repaired on-site or, if necessary, correctly packed and returned to Wilson Audio by the dealer at dealer's sole expense. Wilson Audio will pay return freight of its choice. A returned product must be accompanied by a written description of the defect. Dealer owned demonstration equipment sold at retail within two (2) years of date of shipment to the dealer is warranted to the first retail customer to be free of manufacturing defects in materials and workmanship for the same time periods as if the product had originally been bought for immediate resale to the retail customer. Wilson Audio products are warranted for a period of 90 days, unless extended to 5 years, as provided above, by return and filing of completed Warranty Registration at Wilson Audio within 30 days after product delivery to customer and the product was professionally installed by the Wilson Audio Dealer that sold the product to the customer.

Miscellaneous

ALL EXPRESS AND IMPLIED WARRANTIES NOT PROVIDED FOR HEREIN ARE HEREBY EXPRESSLY DISCLAIMED. ANY LEGALLY IMPOSED IMPLIED WARRANTIES RELATING TO THE PRODUCT SHALL BE LIMITED TO THE DURATION OF THIS LIMITED WARRANTY. THIS LIMITED WARRANTY DOES NOT EXTEND TO ANY INCIDENTAL OR CONSEQUENTIAL COSTS OR DAMAGES TO THE PURCHASER.

Some states do not allow limitations on how long an implied warranty lasts or an exclusion or limitation of incidental or consequential damages, so the above

limitations or exclusions may not apply to you. This Limited Warranty gives you specific legal rights, and you may also have other rights, which vary from state to state.

