

Wilson Audio Specialties, Inc.

X1 / GRAND SLAMM[®]

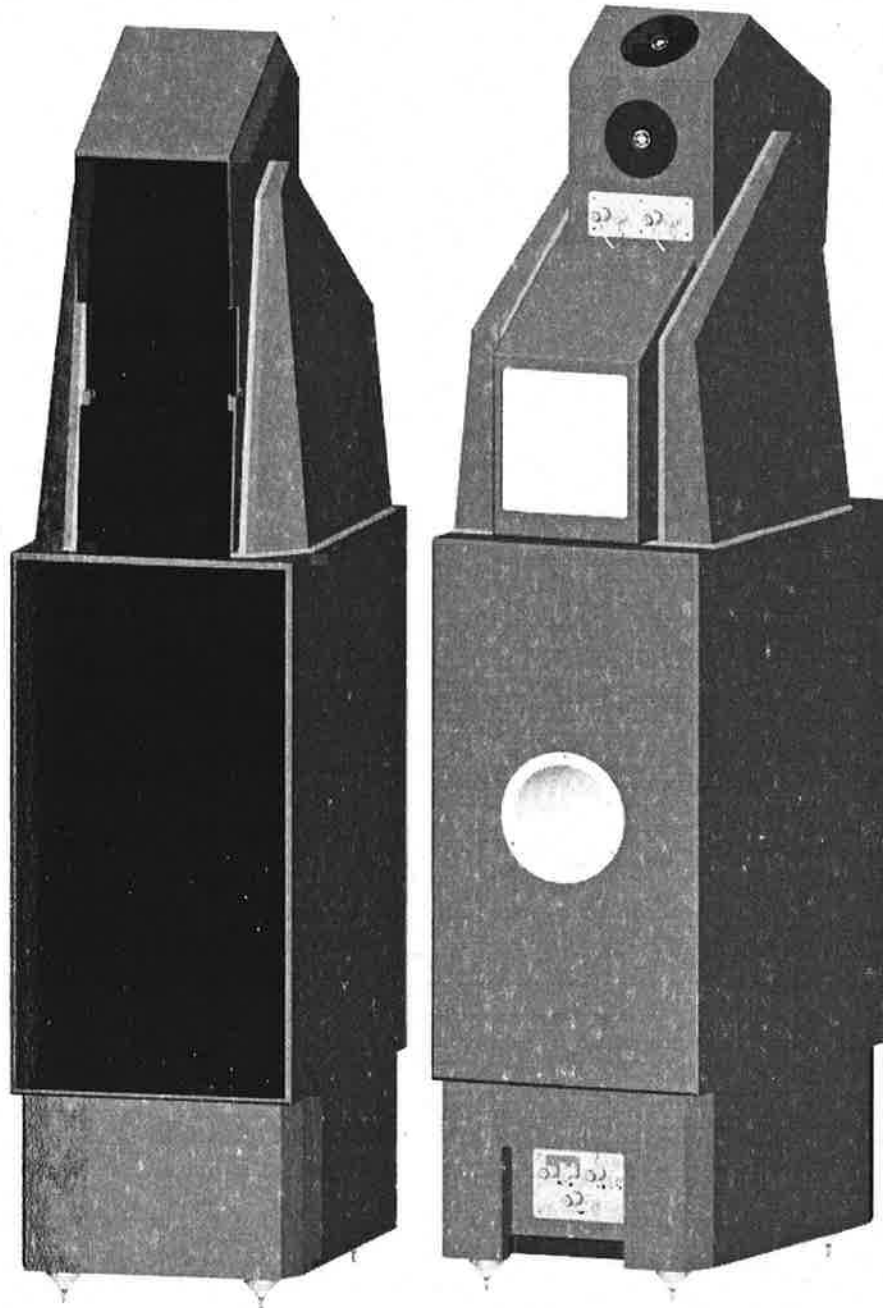

OWNER'S MANUAL



WILSON AUDIO SPECIALTIES, INC
X-1/GRAND SLAMM®
Owner's Manual

Wilson Audio[®] is a registered trademark of Wilson Audio Specialties Inc.

X-1/Grand Slamm[®] is a registered trademark of Wilson Audio Specialties Inc.

This manual was produced by the Wilson Audio Engineering Department in cooperation with Sales and Marketing. The information contained here in is subject to change without notice. Current Revision 1.0, 11/14/1998 if you are in need of a more recent manual please contact your dealer.

The information in this manual is the sole property of Wilson Audio Specialties Inc. any reproduction in whole or in part without the express written permission of Wilson Audio Specialties Inc. is prohibited. No material contained here in may be transmitted in any form or by any means, electronic or mechanical, for any purpose, without the express written permission of Wilson Audio Specialties Inc.

TABLE OF CONTENTS

TABLE OF GRAPHICS	III
COMPONENTS AND DIMENSIONS	IV
SECTION 1.0- ROOM ACOUSTICS	1
FINAL LISTENING ROOM SETUP (VOICING).....	1
SECTION 1.1-ROOM REFLECTIONS.....	2
SLAP-ECHO	2
STANDING WAVES	3
COMB FILTER EFFECT	4
SECTION 1.2-RESONANCE'S	5
STRUCTURAL RESONANCE.....	5
AIR VOLUME RESONANCE.....	5
SECTION 1.3-IN YOUR ROOM	7
ROOM SHAPES	7
SPEAKER PLACEMENT VS. LISTENING POSITION.....	7
CHOOSING A LISTENING POSITION.....	8
SPEAKER ORIENTATION.....	9
SUMMARY	10
SECTION 2.0-CARE OF THE X-1/GRAND SLAMM	11
PAINTED OR WOOD FINISH	11
BREAK IN PERIOD.....	12
SECTION 3.0-UNCRATING THE X-1/GRAND SLAMM	13
INITIAL CHECK	13
UNCRATING THE WOOFER CABINETS	13
MATERIALS REQUIRED.....	13
UNPACKING THE WOOFER.....	13
UNCRATING THE FASCIA ASSEMBLY	14
UNCRATING THE UPPER ARRAY MODULES	14
CRATE CONTENTS: CHECKLIST	16
ASSEMBLE YOUR SPIKES FOLLOWING THESE STEPS:	17
X-1/GRAND SLAMM SET UP	19
SECTION 4.0- INITIAL ASSEMBLY	19
TIMING BLADES	19
CONNECT THE TIMING BLADES TO THE WOOFER CABINET AS FOLLOWS:	20

TABLE OF CONTENTS CONT.

SECTION 4.1-MOUNTING THE UPPER ARRAY MODULES	21
MATERIALS REQUIRED.....	21
MOUNTING PROCEDURE.....	21
MOUNTING THE UPPER CROSSOVER.....	23
CONNECTING THE UPPER RANGE SIGNAL CABLE.....	25
CONNECTOR PLATE JUMPER.....	26
SECTION 4.2- GEOMETRIC TIME DOMAIN ALIGNMENT	27
MATERIALS REQUIRED.....	27
PULSE ALIGNMENT.....	27
ROOM SETUP	27
ALIGNMENT PROCEDURE.....	28
SECTION 4.3- TIME ALIGNMENT EXAMPLE	30
GIVEN:.....	30
SECTION 4.4- FINAL ASSEMBLY	32
MATERIALS REQUIRED.....	32
LOCKING DOWN THE UPPER ARRAY.....	32
SECTION 4.5- SPIKE INSTALLATION.....	33
MATERIALS REQUIRED.....	33
INSTALLATION PROCEDURE.....	33
LEVELING THE X-1 GRAND SLAMM.....	36
SECTION 4.6-CHECKING THE IMAGE HEIGHT	37
SECTION 4.7-ATTACHING THE FASCIA'S.....	38
REQUIRED MATERIALS:.....	38
ATTACHMENT PROCEDURE:.....	38
SECTION-5.0 WARRANTY INFORMATION.....	39
SECTION 6.0 SETTING UP DIFFICULTIES AND TROUBLESHOOTING	41
SECTION 7.0- SPECIFICATIONS	44
APPENDIX A- TIMING CHARTS	A-2

TABLE OF GRAPHICS

FIGURE 1- WOOFER, STAND, AND MAIN CROSSOVER.....	13
FIGURE 2- TIMING BLADE AND FASCIA.....	14
FIGURE 3- UPPER ARRAY MODULES.....	15
FIGURE 4- UPPER ARRAY MODULES	15
FIGURE 5- UPPER ARRAY MODULES.....	15
FIGURE 6- UPPER CROSSOVER.....	15
FIGURE 7- TILTING POLES.....	15
FIGURE 8- X-1 SPIKES.....	17
FIGURE 9- NUMBER LOCATIONS ON FASCIA.....	19
FIGURE 10- EXPLODED VIEW OF FASCIA.....	19
FIGURE 11- ATTACHING THE TIMING BLADE TO WOOFER.....	20
FIGURE 12- UPPER BOLT ASSEMBLY.....	21
FIGURE 13- INSTALLING THE UPPER ARRAY.....	21
FIGURE 14- INSTALLED UPPER ARRAY MODULES.....	22
FIGURE 15- TIGHTENING THE UPPER ARRAY BOLT.....	22
FIGURE 16- INSTALLING THE UPPER CROSSOVER.....	23
FIGURE 17- POSITIONING THE UPPER CROSSOVER.....	23
FIGURE 18- WIRING THE UPPER ARRAY.....	24
FIGURE 19- MAIN CONNECTOR PLATE.....	25
FIGURE 20- LISTENING DISTANCE AND EAR HEIGHT.....	26
FIGURE 21- READING THE MARKINGS ON THE TIMING BLADE.....	29
FIGURE 22- LMRM ALIGNMENT CHART.....	31
FIGURE 23- TIGHTENING THE UPPER ARRAY BOLTS.....	32
FIGURE 24- HOLE COVER LOCATIONS ON BASE/STAND.....	33
FIGURE 25- TILTING THE X-1 FOR SPIKE INSTALLATION.....	33
FIGURE 26- INSTALLING THE SPIKES.....	34
FIGURE 27- SPIKES INSTALLED FIRST SIDE.....	34
FIGURE 28- INSTALLING SPIKES SECOND SIDE.....	35
FIGURE 29- FASCIA BOLT LOCATIONS.....	38
FIGURE 30- FINISHED UPPER ARRAY.....	38

X1 / GRAND SLAMM COMPONENTS AND DIMENSIONS

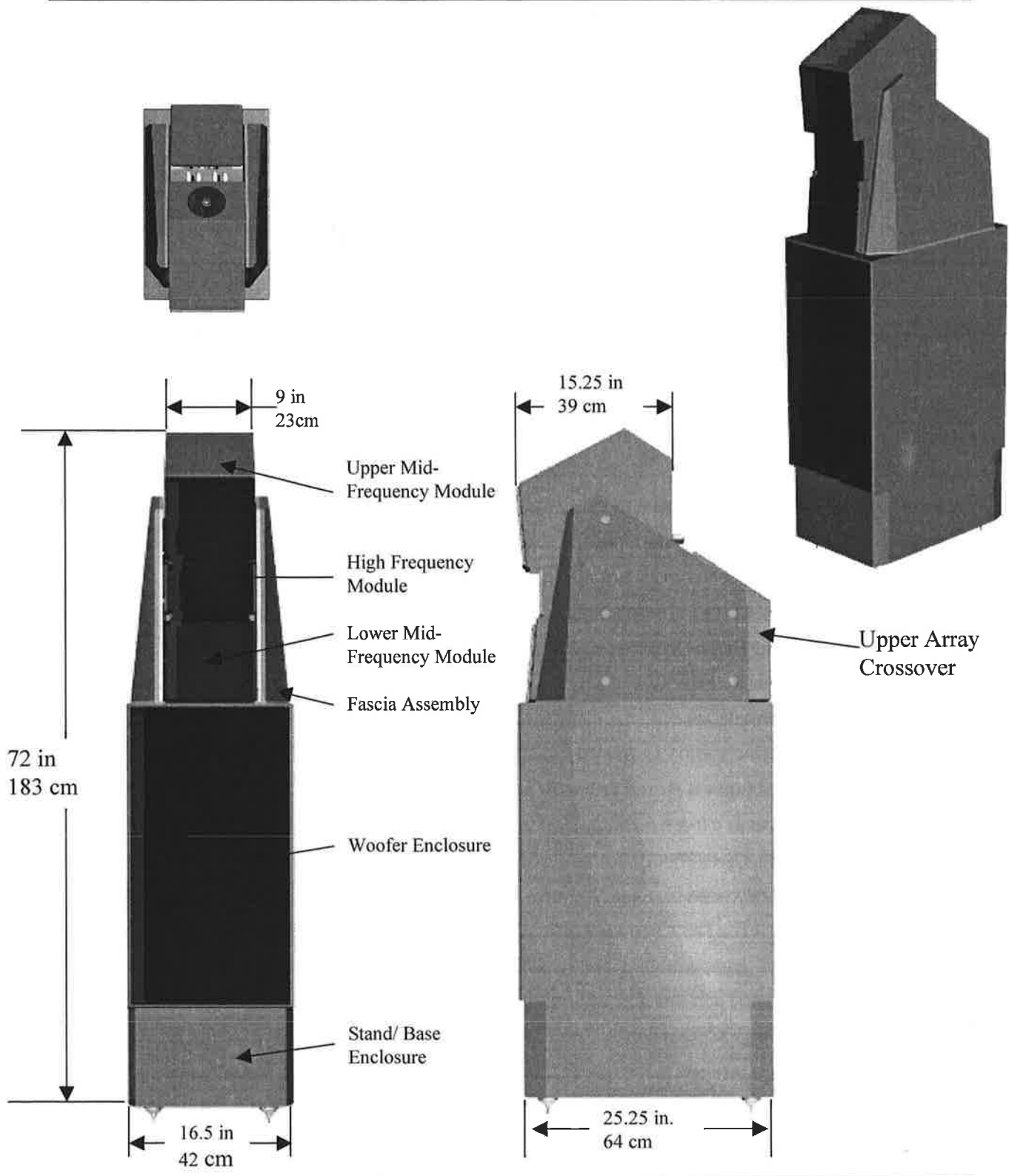

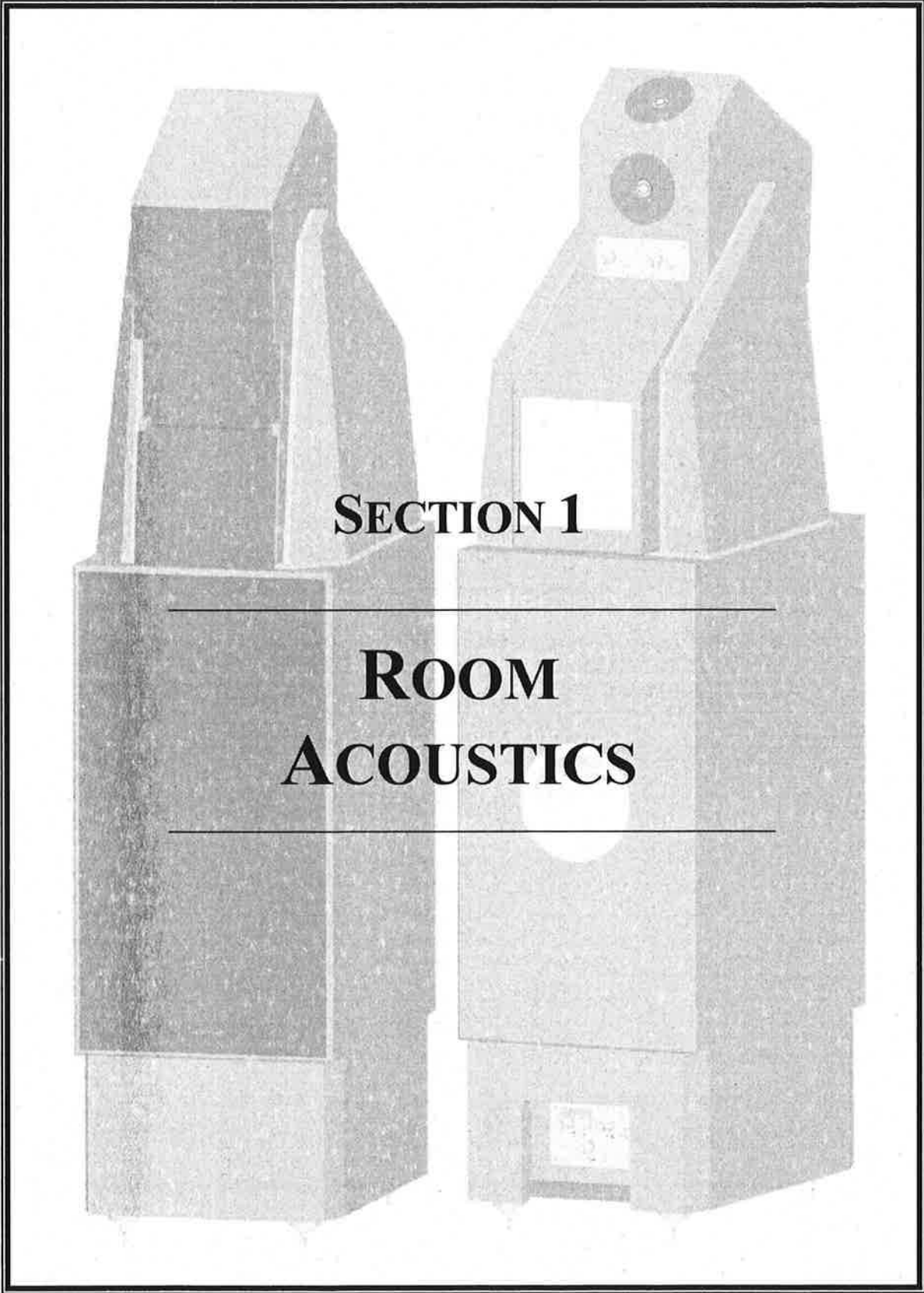

SECTION 1

**ROOM
ACOUSTICS**

SECTION 1.0- ROOM ACOUSTICS

You are surely excited about setting up your X-1/Grand SLAMM loudspeakers and doing some listening, but before you begin we would like to discuss some of the important room acoustical information that will help you set up your loudspeakers properly.

FINAL LISTENING ROOM SETUP (VOICING)

Your X-1/Grand SLAMM loudspeakers will give you years of music satisfaction. However, their high performance characteristics and abilities can only be fully appreciated with the proper acoustical setup.

The following section will present some guidelines on room acoustics and their interactions with loudspeakers. We will also offer some detailed suggestions on the setup of your X-1/Grand SLAMM, but we strongly suggest that you have your local Wilson Audio dealer perform the final speaker “voicing” for you. They are specially trained in setting up Wilson loudspeakers and will ensure that you enjoy the full value of your purchase.

SECTION 1.1-ROOM REFLECTIONS

There are 3 commonly encountered room reflection problems: slap echo's, standing-waves, and comb filter effect.

SLAP-ECHO

Probably the most obnoxious form of reflection is called "slap echo." In slap echo, primarily mid-range and high frequency sounds reflect off of two parallel hard surfaces. The sound literally reverberates back and forth until it is finally dissipated over time. You can test for slap echo in any room by clapping your hands sharply in the middle of the room and listening for the characteristic sound of the echo in the mid-range. Slap echo destroys the sound quality of a stereo system primarily in two ways:

- Adds harshness to the upper mid-range and treble through energy time storage
- Destroys the delicate phase relationships, which help to establish an accurate sound stage. Non-parallel walls do not support slap echo, but rather allow the sound to diffuse.

Slap echo is a common acoustical problem in the typical domestic listening room, because most of these rooms have walls with a hard, reflective nature, usually being only occasionally interrupted by curtains or drapes. Slap echo can be controlled entirely by the application of absorptive materials to the hard surfaces, such as:

- Sonex
- Airduct board
- Cork panels to the hard surfaces.
- Large ceiling to floor drapes
- Carpeting to wall surfaces.

In many domestic listening environments, heavy stuffed furnishings are the primary structural control to slap echo. Unfortunately, their effectiveness is not predictable. Diffusers are sometimes also used to very good subjective effect, particularly in quite large rooms. Sound absorbent materials such as described above will alter the tonal characteristic of the room by

making it sound “deader,” less “bright and alive” and “quieter.” These changes also make the room more pleasant for conversation. Diffusers, on the other hand, tend to not change the tonal balance characteristic of the room, but make the sound smoother and more open.

STANDING WAVES

- Another type of reflection phenomenon is “standing waves.” Standing waves cause the unnatural boosting or accentuation of certain frequencies, typically in the bass, to be found at certain discreet locations on the room. A room generating severe standing waves will tend to make a loudspeaker sound one way when placed in one location and entirely different when placed in another. The effects of standing waves on a loudspeaker’s performance are primarily as follows:
 - Tonal balance
 - Resolution of low-level detail
 - Sound-staging

Standing waves are more difficult to correct than slap echo because they tend to occur at a lower frequency, whose wavelength is long enough to be ineffectively controlled by absorbent materials such as Sonex. Moving speakers about slightly in the room is, for most people, their only control over standing waves. Sometimes a change of placement of as little as two or three inches can dramatically alter the tonal balance of a small system because of standing wave problems. Fortunately, minor low frequency standing waves are well controlled by positioning ASC tube traps in the corners of the room. Very serious low frequency accentuation usually requires a custom-designed bass trap system.

Low frequency standing waves can be particularly troublesome in rooms constructed of concrete or brick. These materials trap the bass in the room, unless it is allowed to leak out of the room, through windows and doors.

In general, placement of the speaker in a corner will excite the maximal number of standing waves in a room, and is to be avoided for most direct radiator, full range loudspeaker systems. Some benefit is achieved by placing the stereo pair of loudspeakers slightly asymmetrically in the listening room. This is so that the standing waves caused by the distance between one speaker, its adjacent walls and floors are not the same as the standing wave frequencies excited by the dimensions in the other channel.

COMB FILTER EFFECT

The comb filter effect is a special type of standing wave noticeable primarily at higher frequencies and shorter wavelengths.

Acoustical comb filtering occurs when sound from a single source, such as a loudspeaker, is directed toward a microphone or listener from a distance. The first sound to reach the microphone is the direct sound, followed by delayed reflected sound. At certain frequencies cancellation occurs, because the reflected sound lags in phase relative to the direct sound. This cancellation is most apparent where the two are 180 degrees out of phase. There is augmentation at other frequencies where the direct and the reflected sounds arrive in phase. Because it is a function of wavelength, the comb filter effect will notch out portions of the audio spectrum at regular octave-spaced intervals. The subjective effect of comb filter effects is as follows:

- Added roughness to the sound
- Reduction of harmonic richness
- Smearing of lateral sound stage image focus and placement

Comb filter effects are caused by side wall reflections. These are best controlled by careful speaker placement and by the placement of Sonex or air duct panels to the part of the wall where the reflection occurs.

SECTION 1.2-RESONANCE'S

Resonance in listening rooms is generally caused by two sources:

- Structures within the listening room
- The volume of the air itself in the listening room

STRUCTURAL RESONANCE

Structural resonance's are familiar to most people as buzzes and rattles, but this type of resonance usually only occurs at extremely high volume levels, and is usually masked by the music. In many wood frame rooms the most common type of structural resonance problem is "booming" of walls and floors. You can test for these very easily by tapping the wall with the palm of your hand or stomping on the floor. To give you an idea of what the perfect wall would sound like, imagine rapping your hand against the side of a mountain. Structural wall resonance's generally occur in the low to mid-bass frequencies and add tonal balance fullness to any system played in that room. They too are more prominent at louder levels, but their contribution to the sound of the speaker is more progressive. Rattling windows, picture frames, lamp shades, etc. can generally be silenced with small pieces of caulk or with blocks of felt. However, short of actually adding additional layers of sheet rock to flimsy walls, there is little that can be done to eliminate wall resonance's.

AIR VOLUME RESONANCE

The volume of air in a room will also resonate at a frequency which is determined by the size of the room. Larger rooms will resonate at a lower frequency than will smaller rooms. Air volume resonance's, wall panel resonance's, and low frequency standing waves, together, combine to form a low frequency coloration in the sound. At its worst, it is a grossly exaggerated fullness, which tends to obscure detail and distort the natural tonal balance of the

speaker system. Occasionally, however, there is just enough resonance to give a little added warmth to the sound... an addition some listeners prefer. Tube traps manufactured by the ASC Corporation are effective in reducing some of this low frequency room coloration. While, custom designed and constructed bass traps, such as perforated Helmholtz resonators, provide the greatest degree of low frequency control.

SECTION 1.3-IN YOUR ROOM

ROOM SHAPES

There are three basic shapes for most rooms: square, rectangular, and L-shaped. A perfectly square room is the most difficult room to set up speakers in because, by virtue of its shape, square rooms are the perfect medium for building and sustaining standing waves. Standing waves are pressure waves created by the integration of sound and opposing, parallel walls which accentuate particular frequencies. They heavily influence the music played by loudspeakers, greatly diminishing the listening experience.

Long, narrow rectangular rooms also pose their own special acoustical problems for speaker setup. They have the ability to set up several standing wave nodes, which will have different standing wave frequency exaggerations depending on where you are sitting. Additionally, these long rooms are often quite lean in the bass near the center of the room. Rectangular rooms are still preferred to square rooms because by having two sets of dissimilar length walls, standing waves are not as strongly reinforced and will dissipate more quickly than in a square room. In these rooms the preferred speaker position for spatial placement and midrange resolution would be on the longer walls. Bass response would be reinforced by speaker placement on the short walls.

In many cases L-shaped rooms offer the best environment for speaker setup. Ideally speakers should be set up along the primary (longest) leg of the room. They should fire from the end of the leg (short wall) toward the bend, or they should be along the longest wall, with the speaker furthest to the bend being inside of the bend. In this way both speakers are firing the same distance to the back wall. The asymmetry of the walls in L-shaped rooms resists the buildup of standing waves.

SPEAKER PLACEMENT VS. LISTENING POSITION

The location of your listening position is as important as the careful setup placement of your X-1/Grand SLAMM speakers in your room. The listening position should ideally be no

more than 1.1 to 1.25 times the distance between the tweeters on each speaker. Therefore, in a long rectangular room of 12' x 18', if the speaker tweeters are going to be 9' apart, you should be sitting 9'11" to 11'3" from the speaker. This would be about halfway down the long axis of the room.

Many people place the speakers on one end and sit at the other end of the room. Needless to say, this will not yield the finest sound. Carefully consider your listening position for optimal performance. Our experience has shown that any listening position which places your head closer than 14" to a room boundary will diminish the sonic results of your listening.

CHOOSING A LISTENING POSITION

Decide where you want your favorite listening position to be. Please remember that your X-1 / Grand SLAMMs will fill any room with the most beautiful sound available. However, for the time aligning advantage, we want to ensure that you get all the benefits that are built into this design. For this purpose we have designed the following questions:

What is the main purpose of your Grand SLAMMs? Is it for a listening room dedicated to 2-channel audio? If yes, you should choose your position carefully to yield the finest sound. Wilson Audio uses a formula: The distance between the 2 woofers of each channel times 1.2 equals the distance you should sit from each loudspeaker.

For instance, if you measure the distance between the center of the left channel woofer to the corresponding right channel woofer and it is equal to 10 feet, multiply it by 1.2. This means that you should sit 12 feet from each X-1 / Grand SLAMM channel.

Are your X-1 / Grand SLAMMs dedicated for a home theater?

Are you going to sit on a couch, or will there be multiple rows of chairs?

If it is a couch, you should center the loudspeakers on the center position of the couch.

Multiple rows of chairs - In this case you should dedicate the 1.2 times equation on your second row of seating. Now more people will enjoy the power of your X-1 / Grand SLAMMs.

Do you still want to listen to 2 channel music at its highest quality? In this way you can enjoy a great time aligned sound from that second seat.

SPEAKER ORIENTATION

Speaker placement and orientation are two of the most important considerations in obtaining superior sound. The first thing you need to do is eliminate the side walls as a sonic influence in your system. Speakers placed too close to the side walls will suffer from a strong primary reflection. This can cause out-of-phase cancellations, or comb filtering, which will cancel some frequencies and change the tonal balance of the music. A good place to start is with the speakers about 18" from each wall and, if you need to move them relative to the side wall, move them away from the wall, not closer.

A very important aspect of speaker placement is how far from the back wall to place the speakers. The closer to the back wall the more pronounced the low bass energy and centering of the image will be. However, this comes at a definite reduction in stage size and bloom, as well as a deterioration of upper bass quality. You must find the proper balance of these two factors, but remember, if you are partial to bass response or air and bloom, do not overcompensate your adjustments to maximize their effects. Overbalanced systems are sometime pleasing in the short term, but long term satisfaction is always achieved through proper balance.

The X-1/Grand SLAMM is designed for maximum phase coherence and pulse replication accuracy when they are aimed directly at the listener or microphone. Thus, your X-

1/Grand SLAMMs should be “toed in.” In other words, the listener, when seated in the listening position, should just barely see the surface of the inner side of the X-1/Grand SLAMM. Toeing in the speakers provides dramatic improvements in resolution of low level detail in the midrange, as well as dramatic improvements in sound staging performance.

SUMMARY

In summary, for optimal tonal balance accuracy, resolution of low level detail, and sound staging performance, the X-1/Grand SLAMMs should be positioned as outlined in this section. Ideally, the speakers should not be positioned too far from the listener, if maximum resolution of low level detail is required. If possible the speakers should be positioned out into the room, slightly asymmetrically away from side and rear walls. The speakers should be “toed in” toward the listener, preferably so that the listener at his seated position can barely see the surface of the inner side of the X-1/Grand SLAMMs as he/she faces the speaker. It is recommended that a distance of 2-3 feet, and possibly more, be maintained between the X-1/Grand SLAMMs and the rear walls and a distance of at least 2 feet be maintained between the front panel of the X-1/Grand SLAMMs and reflective side walls. However, use of sound absorbent materials will reduce the space requirement depending on the room.

By following the guidelines in this manual and your own common judgment, your new X-1/Grand SLAMMs will provide you with a lifetime of pure music reproduction.

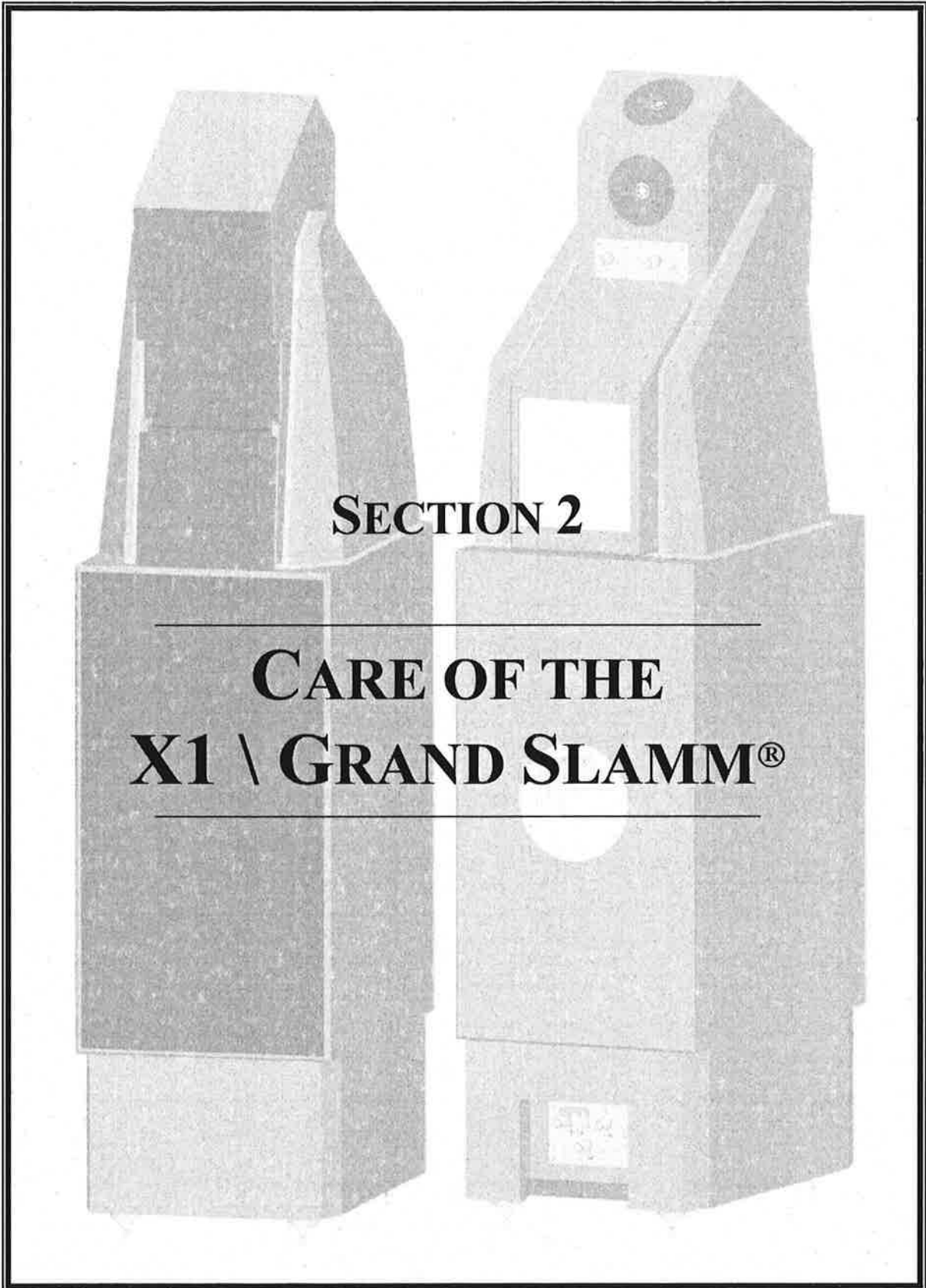

SECTION 2

**CARE OF THE
X1 \ GRAND SLAMM®**

SECTION 2.0-CARE OF THE X-1/GRAND SLAMM

PAINTED OR WOOD FINISH

Your X-1/Grand SLAMM loudspeakers are hand-painted with Wilson gloss paint and hand polished to a high luster. While the finish seems quite dry to the touch, final curing and complete hardening takes place over a period of several weeks. To protect the finish of the X-1/Grand SLAMMs during final manufacture, shipment, and setup in your listening room, we have applied a removable layer of protective film over the finish. We recommend that this film be left in place until the speakers are in their final location in your listening room. Once you have determined their final position, remove the film by peeling it off. **Do not leave this film on indefinitely, as it may leave impressions on the paint.** It is important that the delicate paint finish of the X-1/Grand SLAMMs be dusted carefully with the dust cloth, which has been provided. We recommend that the following procedure be observed when dusting the speakers:

- Blow off all loose dust.
- Using the special dust cloth as a brush, gently whisk off any remaining loose dust.
- Shake out the dust cloth.
- Dust the finish, using linear motions in one direction parallel to the floor. Avoid using circular or vertical motions.

Because the paint requires a period of several weeks to fully cure, we recommend that no cleaning fluids such as glass cleaners be used during this initial period of time. When the paint is fully cured, heavy fingerprints and other minor smudges may be removed with a glass cleaner. Always use the dust cloth. Stronger solvents are not recommended under any circumstances. Consult your dealer for further information if required. Periodic polishing may be desired over the years to maintain the high luster of the finish. We recommend a non-abrasive Carnauba-based wax and soft cloth.

BREAK IN PERIOD

All audio equipment will sound its best after its components have been broken in for some period of use. Wilson Audio breaks in all woofers and mid-range drivers for a 12 hour period. All drivers then are tested, calibrated, and matched for their acoustical properties. In your listening room, expect 25 to 50% of break-in to be complete after two hours of playing music fairly loudly. Ninety percent of break-in is complete after 24 hours of playing. Playing a “disc repeat” overnight can accomplish this task quickly. Wilson Audio recommends chamber music for this task.



SECTION 3

**UNCRATING THE
X1 \ GRAND SLAMM[®]**

SECTION 3.0-UNCRATING THE X-1/GRAND SLAMM

Note: You will have many modules to unpack that will need to be separated into right and left channels. Clear out 2 spaces, one for your left and one for your right channel modules. Place the ODD numbered modules in the LEFT channel section and the EVEN in the RIGHT channel section.

INITIAL CHECK

The X-1/Grand SLAMMs are sent to you in 8 wooden crates and one cardboard box.

Upon receiving these crates, please check their condition. If any of the crates are damaged, please report it to the shipping company for insurance verification.

MATERIALS REQUIRED

- Metal shears
- Electric screw driver
- Phillips head drive bit

UNCRATING THE WOOFER CABINETS

A minimum of two strong adults is required to set up the system. Locate the two largest crates numbered 1 and 2. These contain the woofer enclosures and are the first components of the systems to unpack (see Figure 9).

Note: These two woofer enclosures are very heavy, and care should be taken to prevent injury.

UNPACKING THE WOOFER

- Open the top of each crate and determine the side where the casters are connected to the bottom of the woofer module.
- Remove the packing material from between the casters and set the crate up so that the casters on the woofer are toward the floor.

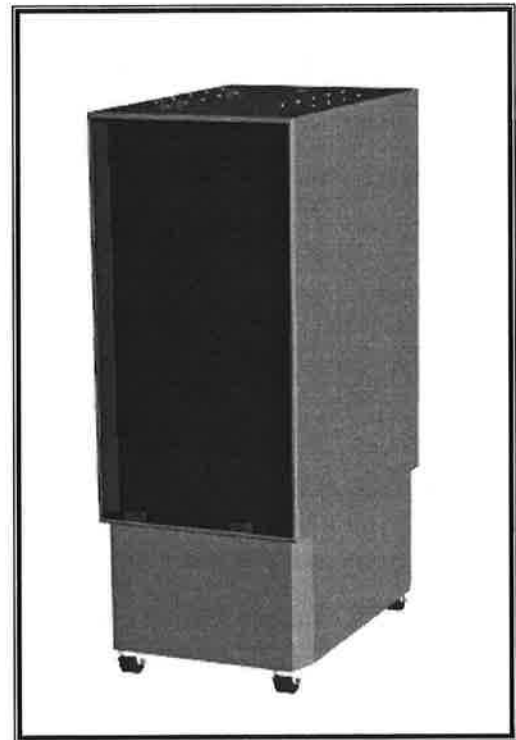

FIGURE 1 CRATES #1 &2, WOOFER ENCLOSURE

-
- While one person holds the crate, the other person should roll the woofer enclosure out of the crate. Be very careful not to scratch the module during this process.

Finally, move the woofer cabinets over to the “zone of neutrality” as determined by the Wilson Audio set-up procedure. If you have not yet performed this room analysis please refer to section 1 of this manual.

UNCRATING THE FASCIA ASSEMBLY

Next you should unpack the 2 long and narrow crates. These contain the fascia panels. Place them on the ground with the aluminum side DOWN.

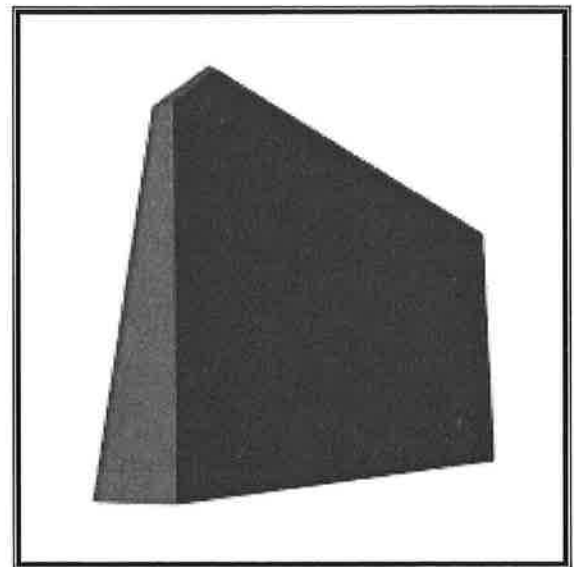

FIGURE 2 CRATES # 3 &4, TIMING BLADE AND FASCIA

UNCRATING THE UPPER ARRAY MODULES

Remember to place the odd numbered modules in the LEFT channel section and the even numbered in the RIGHT channel section. Now unpack the remaining crates. Be very careful the remaining modules are made of a Methacrylic Ceramic compound and are very prone to chipping. Figures, 3-7, show the contents of each of the remaining crates.

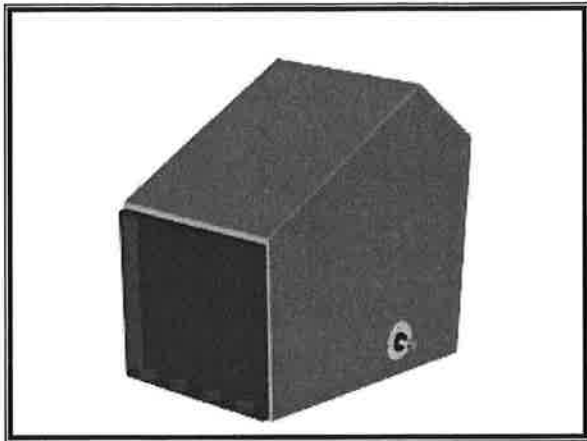

FIGURE 3 CRATES #5 & 6, ARRAY
MODULES

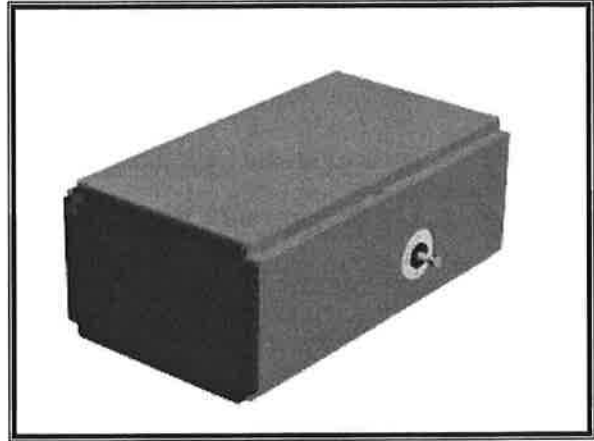

FIGURE 4 CRATES #5 & 6, ARRAY
MODULES

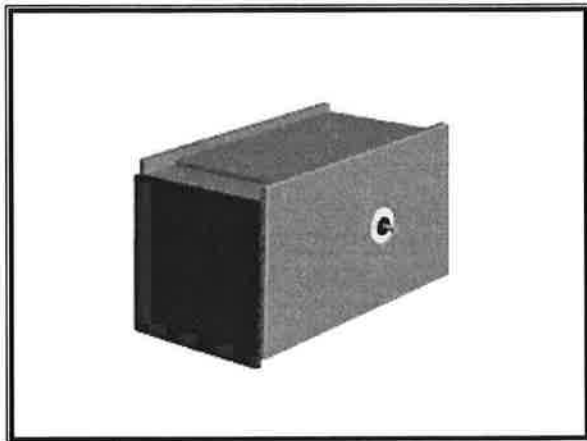

FIGURE 5 CRATES #5 & 6, ARRAY MODULES

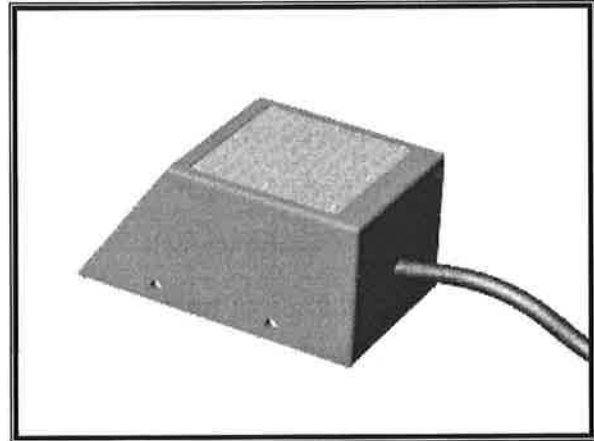

FIGURE 6 CRATES #7 & 8, UPPER
CROSSOVER

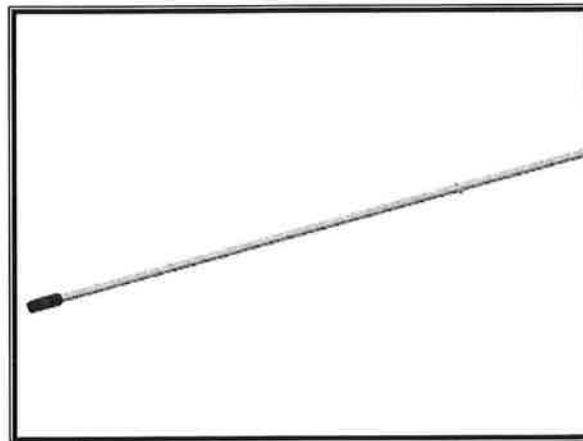

FIGURE 7 CRATE #9, TILTING POLES

CRATE CONTENTS: CHECKLIST

Now that you have everything unpacked you can inventory your items.

- 1- Owners manual
- 2- Base modules (left & right channel)
- 2- Lower mid-range modules (left & right channel)
- 2- High frequency modules (left & right channel)
- 2- Upper mid-range modules (left & right channel)
- 4- Fascia plates with aluminum timing blades attached
- 2- 4' aluminum poles
- 8- Diode bodies
- 8- 3/8-16x 1.5 set screw
- 8- Spikes, with nuts
- 2- "T" handle wrenches, size 1/4", 5/32", 3/32"
- 1- 3/4" Combo wrench
- 1- 9/16" Combo wrench
- 8- Flat aluminum washers
- 12- Plastic washers (for timing blades)
- 2- 3.2 ohms Resistors
- 3- Polishing cloths
- 8- Brass spike pads
- 2- Taps, 5/16"-18, 3/8"-16
- 1- Tap Handle
- 48- 1/4"-20x 3/4" Button headed capscrew
- 25- 5/16"-18x 1 3/4" Socket headed capscrew
- 14- .328"x.562" washers
- 25 - Wing hole covers

After set up of the system keep the shipping crates in case of future shipping needs.

ASSEMBLE YOUR SPIKES FOLLOWING THESE STEPS:

- Remove the diodes and move the nut to about 2 threads from the point. This will allow for greater movement when leveling the loudspeaker systems.
- Screw the spikes into the diode until the nut is against the spike body. Be careful that the nuts do not turn while inserting and threading into the diode. Note: Do not tighten these assembled spikes. You will need to unscrew them when you level the X-1 / Grand SLAMMs.

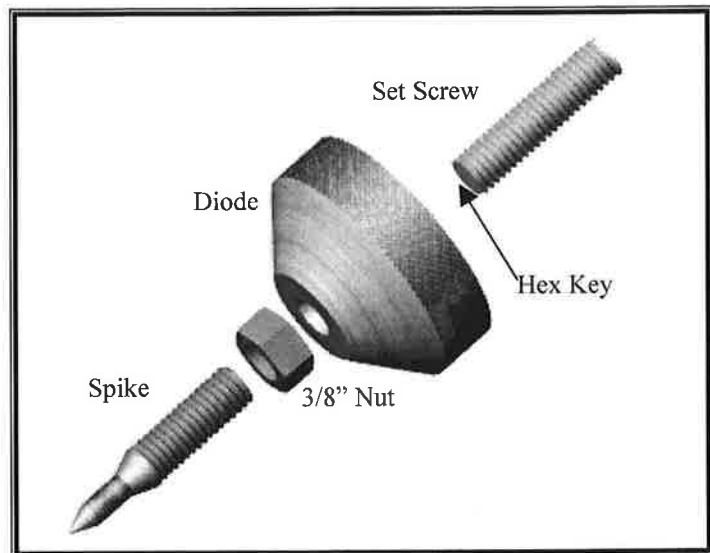
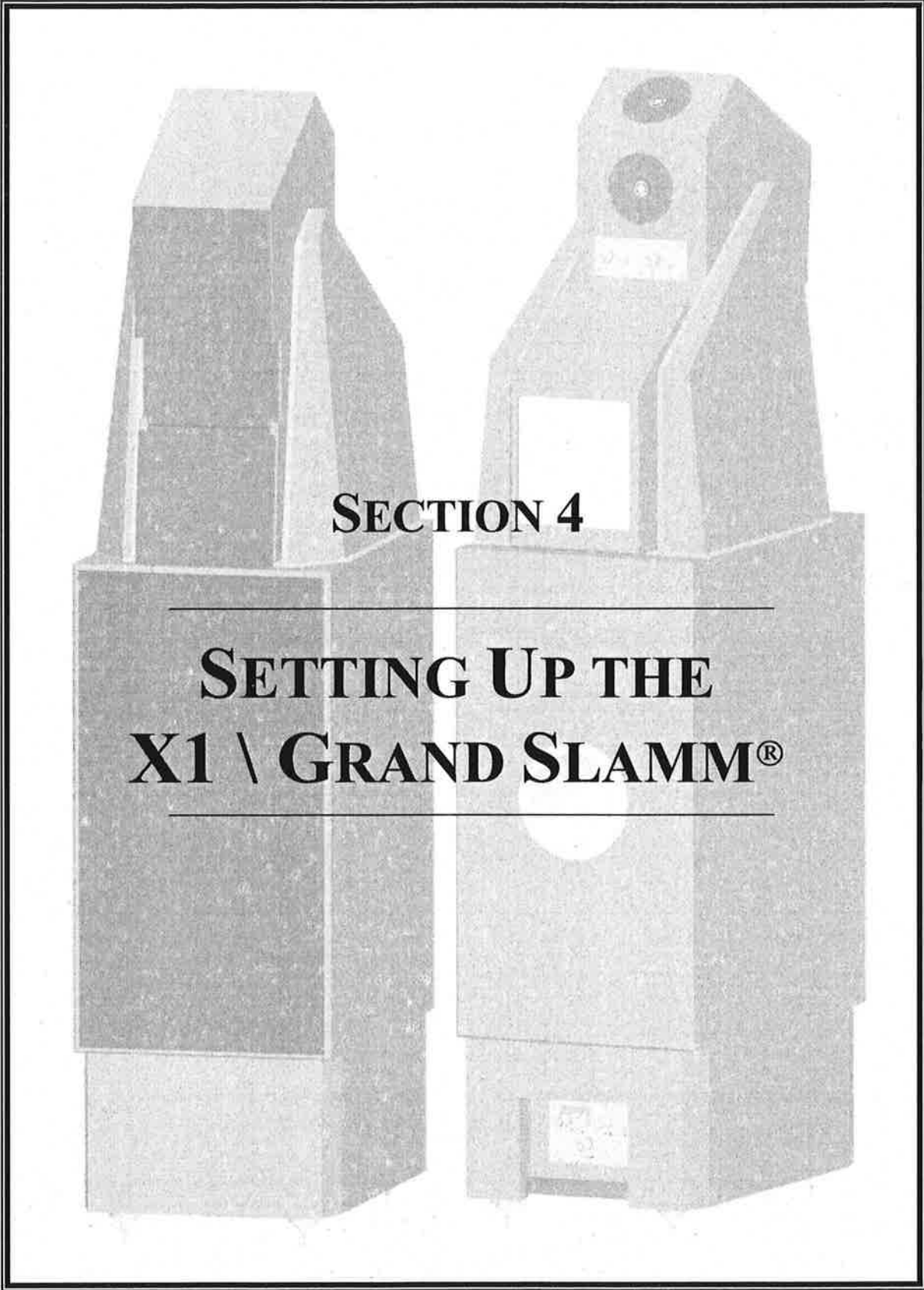

FIGURE 8 X-1 SPIKES

- Place the set screw into the other end of the diode. Note: Place the Allen (hex key) end into the diode. This will ensure that if for any reason you have to move your Grand SLAMMs, you will be able to withdraw the set without grabbing them with pliers, ruining the threads in the process. Screw the set screw into the diode until it meets the spike.
- Place the assembly aside until it is needed during the installation

THIS PAGE INTENTIONALLY LEFT BLANK



SECTION 4

**SETTING UP THE
X1 \ GRAND SLAMM®**

X-1/GRAND SLAMM SET UP

SECTION 4.0- INITIAL ASSEMBLY

In order to realize the capabilities of the X-1/Grand SLAMM we recommend that you have it installed by a trained Wilson Audio installer. Your dealer will have a person trained in the art of the X-1/Grand SLAMM installation. If you choose to do this installation yourself, here are some guidelines to assist you. These guidelines come from many years of experience and should be followed closely.

The first step in building your Grand SLAMMs is to remove protective film. To remove, just start at the edge and peel it off.

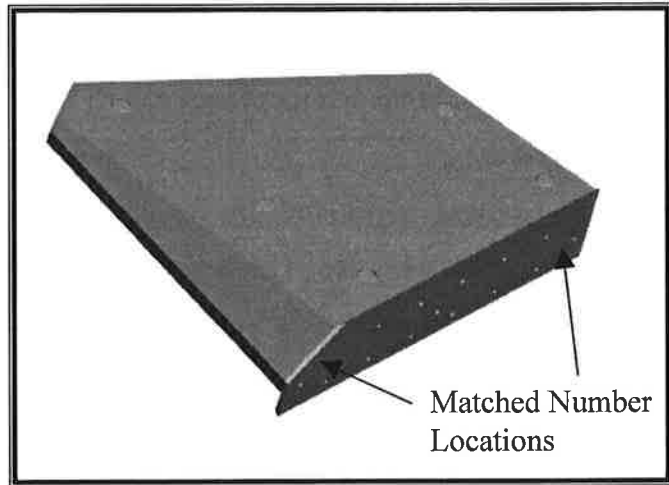

FIGURE 9 MATCHED NUMBER LOCATIONS ON FASCIA

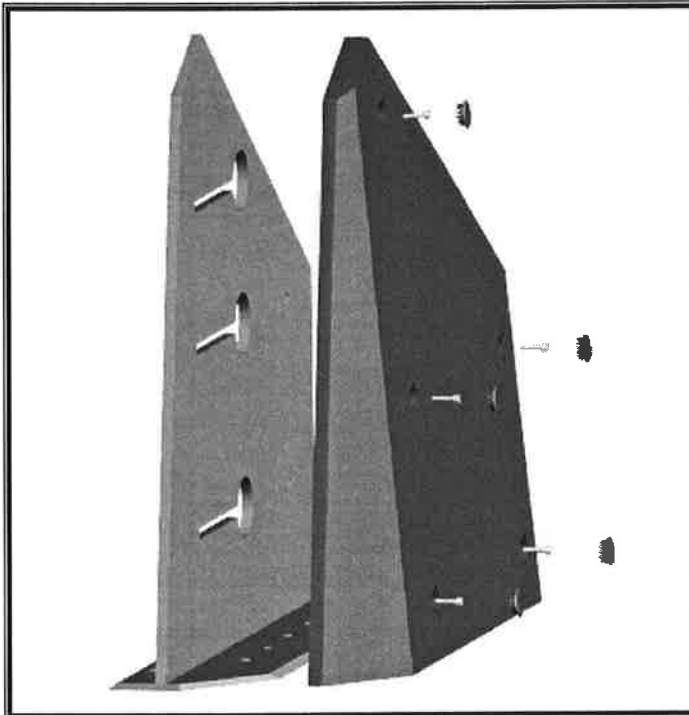

FIGURE 10 EXPLODED VIEW OF FASCIA

TIMING BLADES

Each timing blade has been marked with two numbers on the bottom surface. There are corresponding numbers on the woofer enclosure(see Figure 9). Set the timing blades near the respective woofer enclosure. Remove the fascia from the timing blades, noting how they fit together and the lengths of the screws in the holes (see Figure 10). Each fascia and blade are a matched set, be sure to keep them together. The bottom surface of each fascia and the corresponding surface of the timing blade have been marked A-D, Fascia A matches timing blade A, etc.

CONNECT THE TIMING BLADES TO THE WOOFER CABINET AS FOLLOWS:

- Place the timing blades on the X-1/Grand SLAMMs.
- Bolt them to the woofer module with the button head screws. Note: Do not tighten the screws yet (see Figure 11).
- Place all of the screws in each timing blade so that there is some "movement" in position.
- Slide your finger along the outside edge and make sure that the timing blade is flush to the outside edge of the woofer enclosure.
- Tighten all the screws *ONLY TIGHTEN TO A MEDIUM HAND TIGHT.*

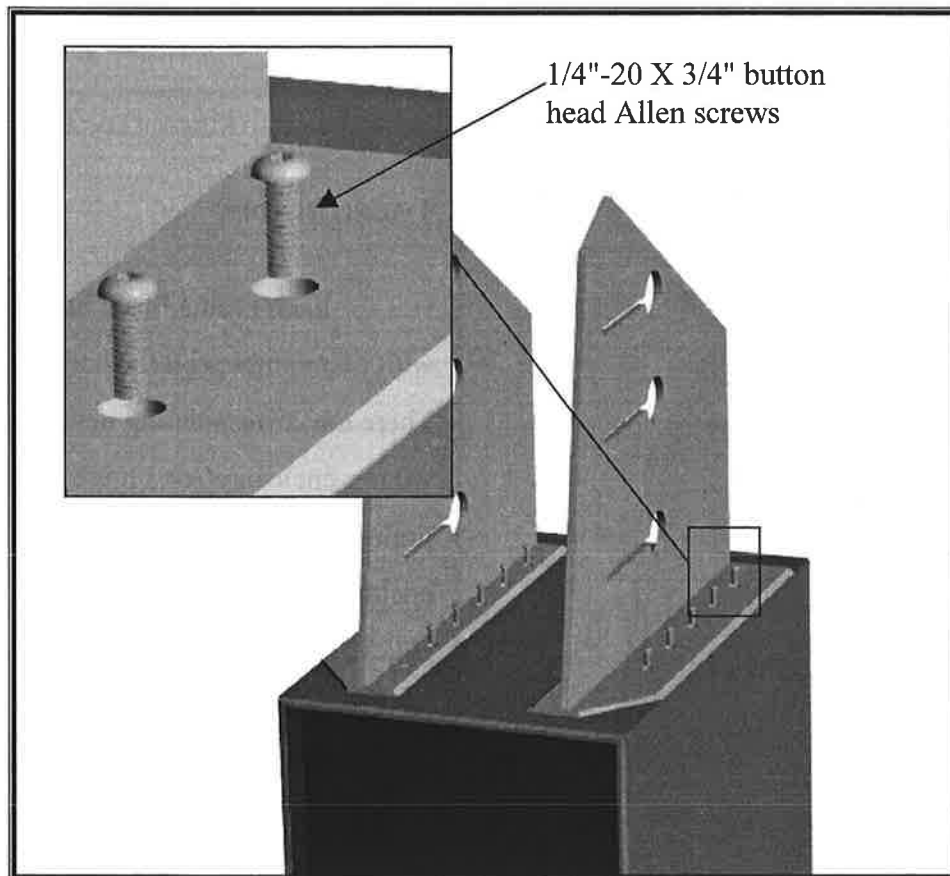

FIGURE 11 ATTACHING TIMING BLADE TO WOOFER TOP

SECTION 4.1-MOUNTING THE UPPER ARRAY MODULES

MATERIALS REQUIRED

- ¼" T handled Allen wrench
- 20, 5/16"-18 x 1 ¾" bolts
- 12, 5/16 washers
- 8, 1 ¼" washer
- 12, alignment washers

MOUNTING PROCEDURE

Locate the crates marked 5 and 6.

These crates contain the upper array modules. Each crate contains matched UMRM, HFM, and LMRM modules. The serial number on each module matches the serial number on the back of the woofer cabinet.

The lower mid-range module (LMRM) is installed first. Install the module as follows:

- With the brass cones pointing down, carefully lower LMRM between the timing blades and set it on top of the woofer enclosure (see Figure 13).

Note: Take special care not to scratch or damage the freshly painted surface.

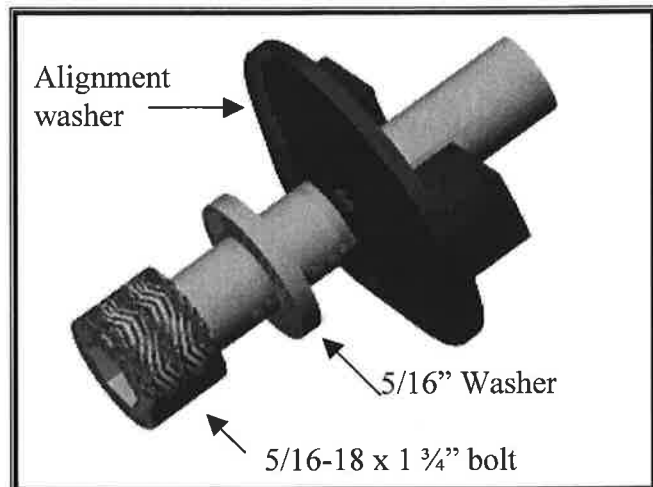

FIGURE 12 UPPER BOLT ASSEMBLY

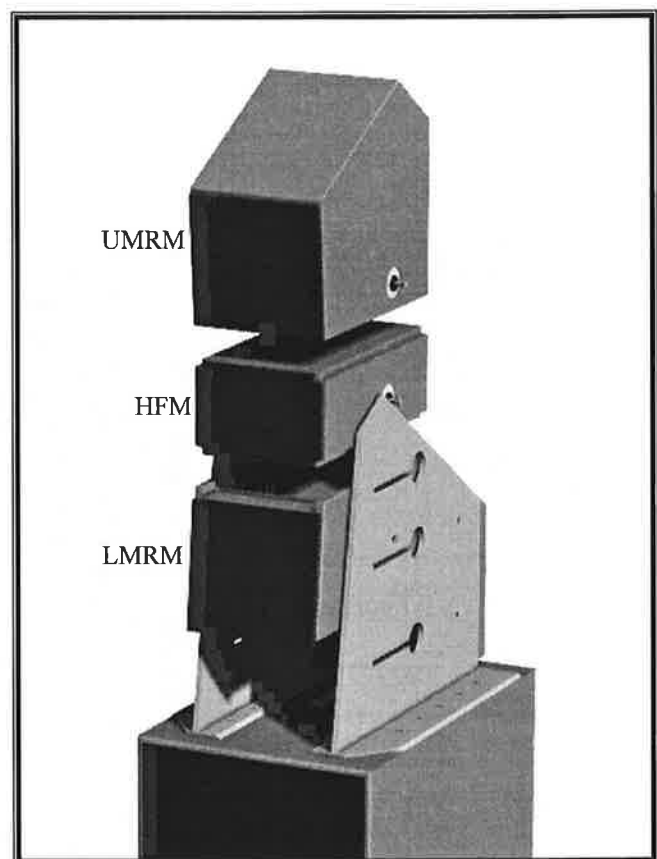

FIGURE 13 INSTALLING THE UPPER ARRAY MODULES

-
- Center the LMRM between the timing blades.
 - Insert the two 5/16" -18 X 1 3/4" bolts, washers, and alignment washers. Only tighten the bolt half way (see Figure 15).

Repeat the same steps with the high frequency module (HFM), and again with the upper mid-range module (UMRM). If you have not worked on both channels, repeat the above steps on the other channel at this time.

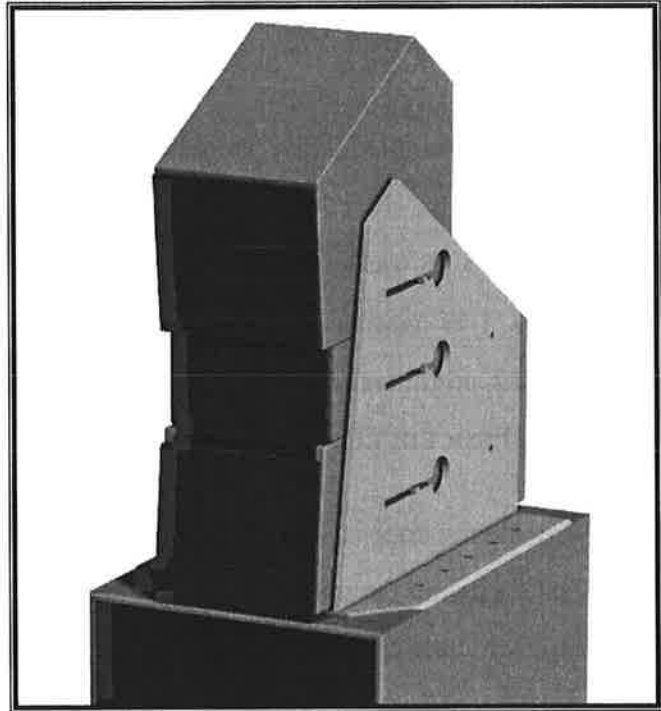

FIGURE 14 UPPER ARRAY MODULES INSTALLED

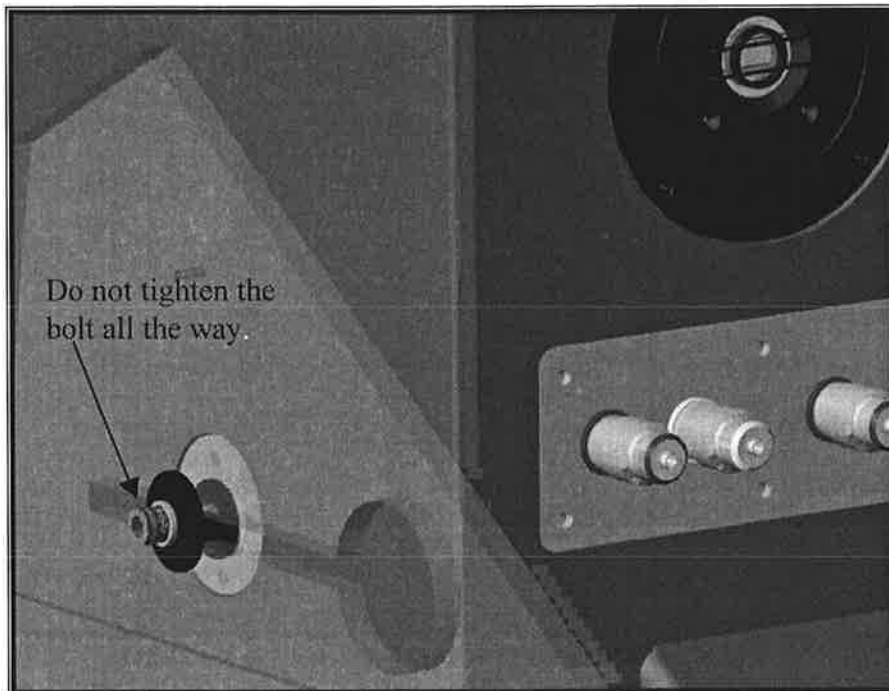

FIGURE 15 HALF WAY TIGHTENED BOLT

MOUNTING THE UPPER CROSSOVER

The upper crossover sub-assemblies (U C/O S-A) are matched to each woofer. For example, if the serial number of the X-1 pair is 135 and 136, attach the U C/O S-A to the woofer with the same serial number. Install the U C/O S-A as follows:

- Insert the upper range signal cable through the hole on the top of the woofer enclosure

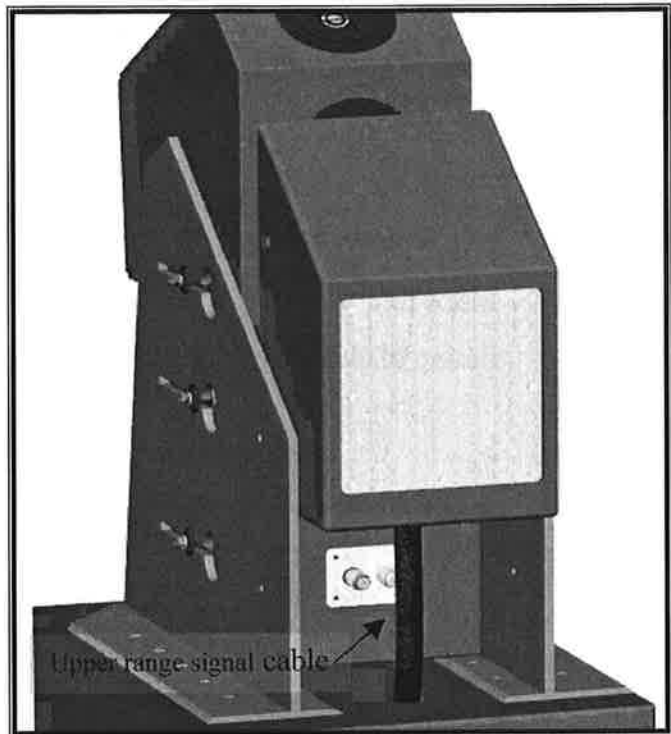

FIGURE 16 INSTALLING THE UPPER CROSSOVER

(see Figure 16).

Note: It may take two or three tries for the cable to come out near the main connector plate.

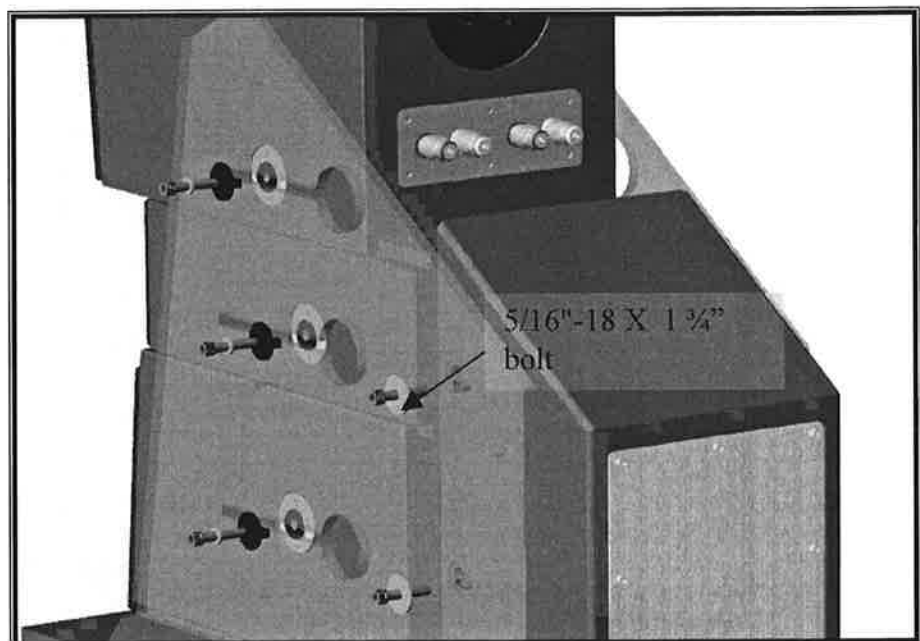

FIGURE 17 POSITIONING THE UPPER CROSSOVER

- Position the U C/O S-A as shown in Figure 17

-
- Center the U C/O S-A between the timing blades such that there is equal space between the U C/O S-A and the adjacent blade.
 - Attach the labeled wires from to U C/O S-A to the correct upper array modules (see Figure 18 below)
 - Insert four 5/16"-18 X 1 3/4" bolts and 1 1/4" washers through the four holes in the timing blades, about 1/2 the length of the bolts - Do not tighten at this time.

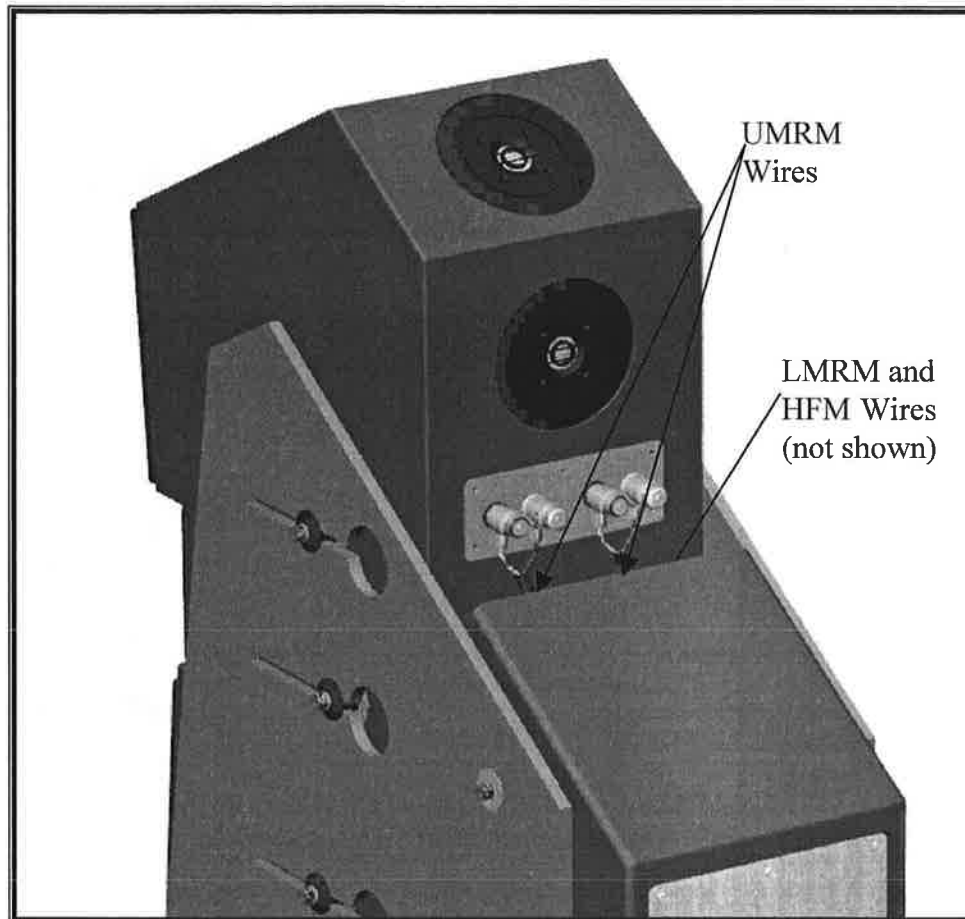

FIGURE 18 ATTACHING THE WIRING TO THE UPPER ARRAY

CONNECTING THE UPPER RANGE SIGNAL CABLE

The Wilson Audio X-1/Grand SLAMMs use WBT connectors on all cable connections. They are superior to most common connectors.

A note about WBT connectors: These connectors can loosen if they are not properly secured. One method of securing them is to grasp the wire and wiggle it while tightening. Once they are secure, they will remain that way.

The upper range signal cable is connected to the connector plate at the rear of the X-1 base. This is accomplished as follows:

- Carefully remove the protective sleeve from the end of the cable
- Connect the cable to the "array out" terminals on the connector plate (see Figure 19).

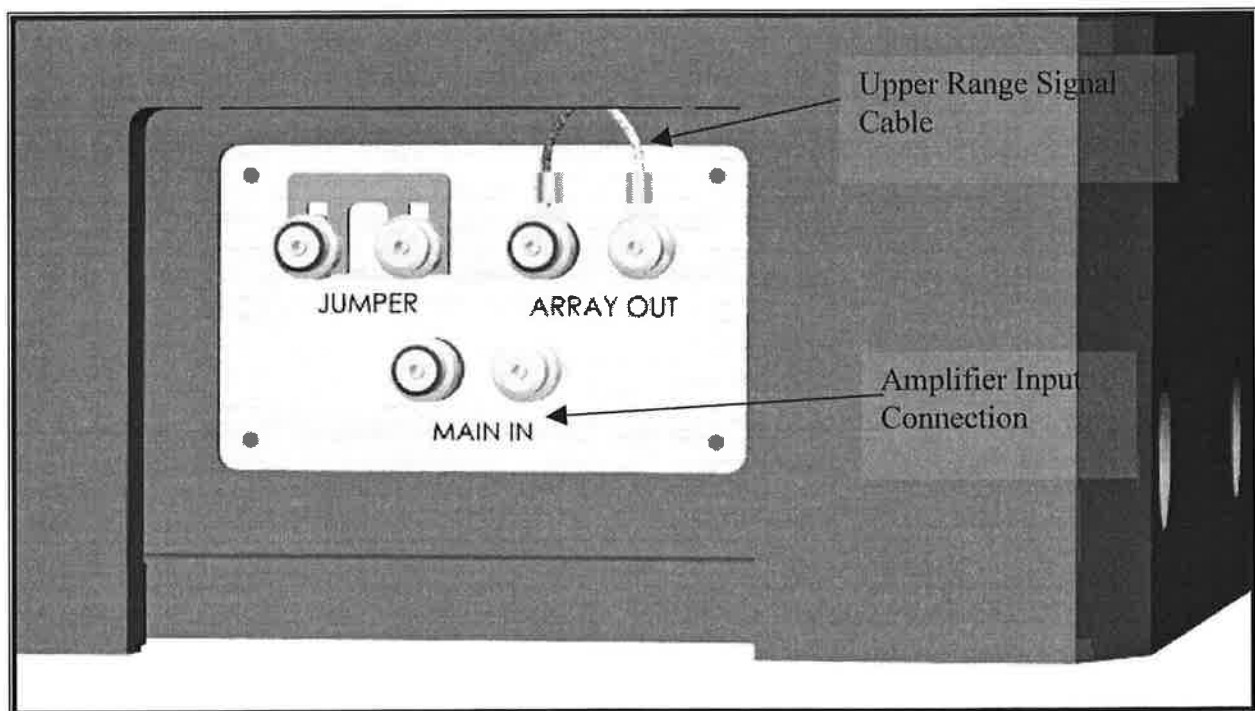

FIGURE 19 MAIN CONNECTOR

CONNECTOR PLATE JUMPER

A jumper has been provided for pulse alignment purposes. This jumper is on the main connector plate, and when removed, the woofers are no longer active. The jumper has been installed correctly at the factory. **At all times, except during instrument pulse aligning the system, the jumper is to remain connected between jumper terminals.**

The X-1 system is now ready to be positioned in your room. *NOTE: Until the X-1/Grand Slamm's final position in your room is determined **fully**, do not tighten the hardware in the modular array.*

SECTION 4.2- GEOMETRIC TIME DOMAIN ALIGNMENT

MATERIALS REQUIRED

- Tape measure
- Known listening position
- Geometric timing charts (Appendix A)

PULSE ALIGNMENT

Pulse alignment accuracy of the X-1/Grand SLAMM has been established and verified at Wilson Audio's R&D laboratory. The graphs and charts used in this section are a result of this testing.

ROOM SETUP

The X-1/Grand SLAMM system allows for different listening distances (away from the speakers) and listening ear heights (measured distances from the floor up to your ear), see Figure 20 below. For each distance/ear height combination there is a unique alignment geometry.

To make correct in home set up of the X-1/Grand SLAMM possible without test equipment, Wilson Audio has measured the correct geometric time domain alignment for different distance/ear height combinations. This information is provided in Appendix A. By measuring the ear height and the distance from the speaker to the listening position, you will be able to align the system for your listening position. Section 4.1 gives an example of this alignment procedure.

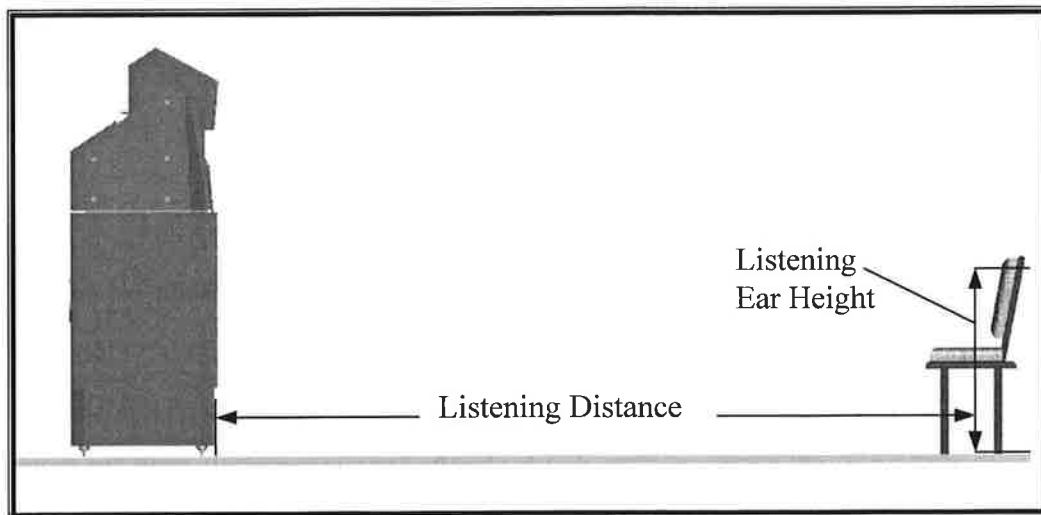

FIGURE 20 LISTENING DIST. AND EAR HEIGHT

ALIGNMENT PROCEDURE

The timing sheets are set into precise increments. The vertical axis is numbered 1-10 with 4 “tics” between each number. They correspond to the timing blade marks. Find the proper intersections and align the module for your setup.

1. Repeat each step of this procedure on the left and right channels simultaneously.
2. Remove the timing sheets from this booklet and place them on a tabletop.
3. Make sure that you are in your exact listening position. Be certain that your ear is aligned with your measured distance (as was stated of in the Wilson Audio setup procedure).
4. While sitting, have someone measure your ear height from the floor. You should be relaxed in your chair, as you would be when listening to music.
5. Look toward the bottom of your timing sheets to the measured listening distance. Place a small dot {•} on your listening distance - On all three sheets.
6. Place the timing sheet marked LOWER MID RANGE MODULE in front of you. Using a piece of paper from left to right, place it over your listening distance.
7. Move your eyes up till you reach your ear height curve. Place a small dot {•} on that intersection. Now remove the paper and find just where you should place your LOWER MID-RANGE MODULE. Gently slide your LOWER MID-RANGE MODULE to line up the plastic hash mark on the washer that is attached to your module with the marks on

the timing blade (see Figure 21). *Note: Make sure the module is centered in between the timing blades.* If it is not, center it and then move the module to line up again. These modules are extremely sensitive.

You must be absolutely certain that they are lined up to within 1/2 of a mark on the timing blade. Any deviation from this procedure will be audible.

8. When you are certain that you have it correct, you should hand tighten both sides at once. Tighten the modules till the washer cannot move. The module will be secure from this point on. *Note: You must tighten both sides at the same time, otherwise you will pull the module off center.*

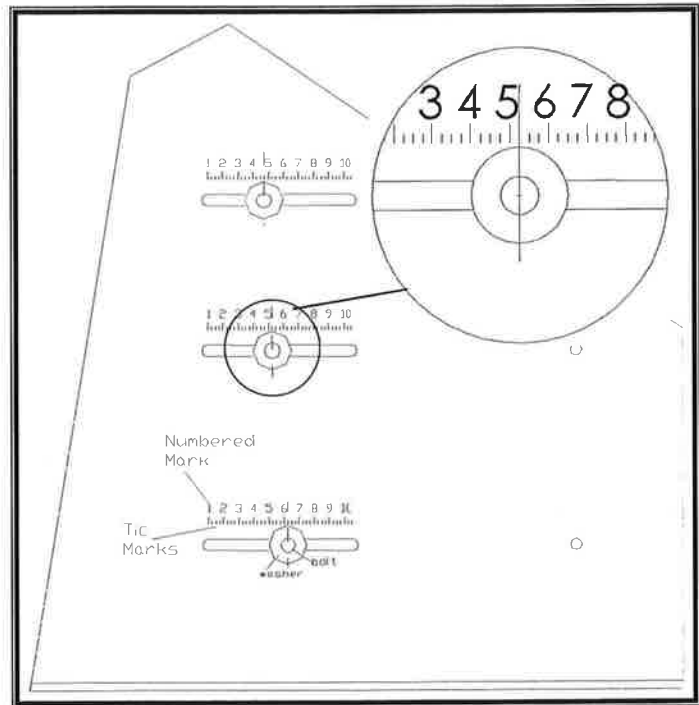

FIGURE 21 READING THE TIMING BLADE

9. Repeat step 6 through 8 for the ULTRA HIGH FREQUENCY and UPPER MID-RANGE MODULES.
10. Check your time aligned modules again. Sometimes tightening the crossover bolts will loosen the modules.

SECTION 4.3- TIME ALIGNMENT EXAMPLE

For this example the word "Tic" will be defined as one of the smaller marks between the numbered marks on the timing blades (see Figure 21).

GIVEN:

- Right channel listening distance is 12 feet.
- Left channel listening distance is 12 feet 3 inches.
- Ear height is 40 inches above the floor.

The proper time alignment for the right channel begins by locating the 40 inch ear height line on Figure 22 (next page), which is the geometric graph for the lower mid-range module. The ear height is shown on the right side of the page.

At the listening position of 12 feet the geometric alignment position for the center of the 5/16"-18 X 1 3/4" bolt reads 6 plus 1 tics.

The high frequency module data are given in Appendix A. The geometric alignment position for this module reads 7 plus 1 tic. The upper mid-range module data are given in Appendix A, the geometric alignment position for this unit reads 4 plus 2 1/2 tics

For the left channel, the procedure is the same. The geometric alignment for the left channel is:

- Lower mid-range module: 6 plus 1 tic.
- High frequency module: 7 plus 1 1/2 tics.
- Upper mid-range module: 4 plus 3 tics.

For this example the X-1 Grand SLAMMs system have been properly aligned for the listening position and after final assembly will be ready for use.

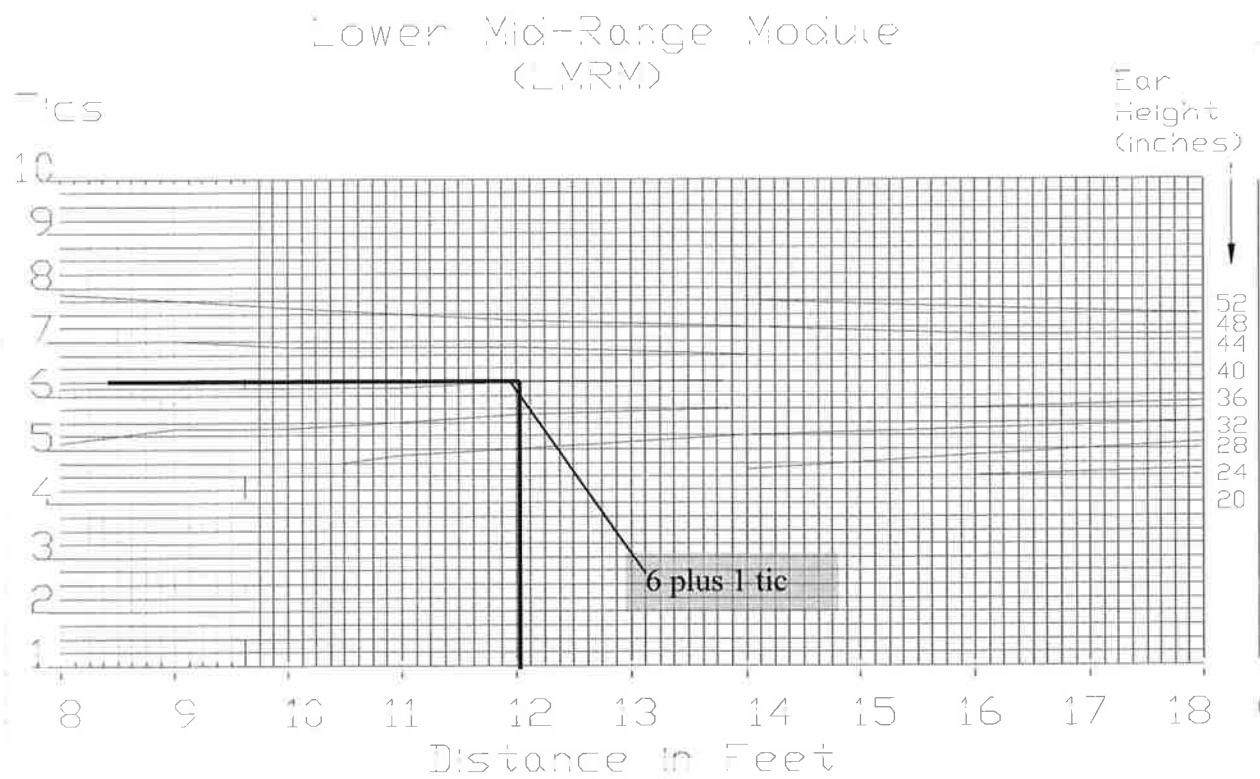

FIGURE 22 LMRM ALIGNMENT CHART

SECTION 4.4- FINAL ASSEMBLY

MATERIALS REQUIRED

- 1/4" T-handled Allen wrench

LOCKING DOWN THE UPPER ARRAY

Being careful not to change the alignment settings of the array modules tighten the 5/16"-18 X 1 3/4" bolts as follows (see Figure 23):

- Four U C/O S-A bolts. Finger tighten the top two first, then add a 1/4 turn with the wrench. Finger tighten the bottom two.
- Finger tighten the upper mid-range module bolts.
- Finger tighten the high frequency module bolts.
- Finger tighten the lower mid-range module bolts.

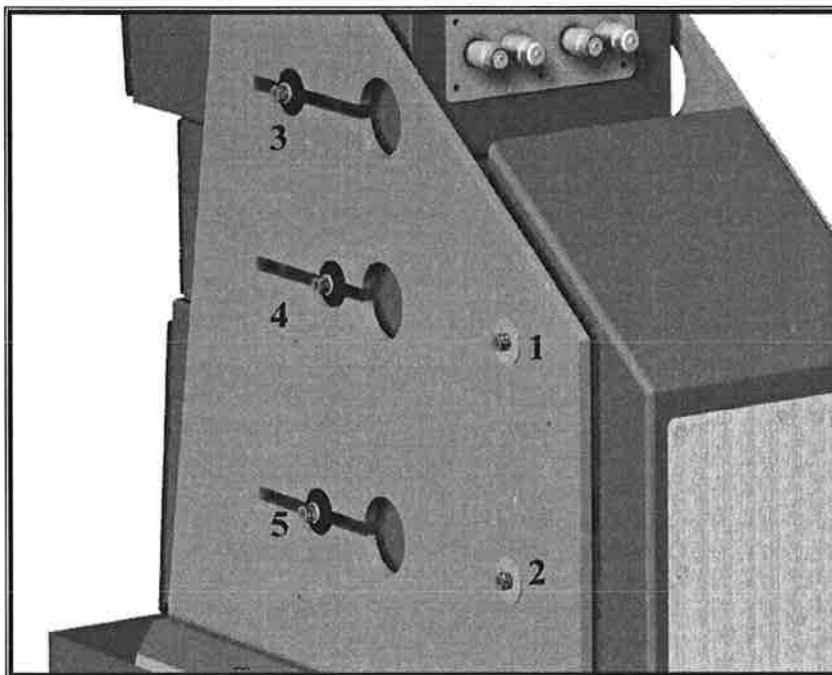

Remember to only finger tighten the array modules. *Over tightening can damage the array modules.*

FIGURE 23 TIGHTENING ORDER FOR UPPER ARRAY BOLTS

SECTION 4.5- SPIKE INSTALLATION

Note: This is a 2 person job. Do not attempt this with a single person. The X-1/Grand SLAMMs weigh over 650-lbs. They may seriously injure someone if tipped over.

MATERIALS REQUIRED

- 3/32 T-handled Allen wrench
- 8 sets of spikes
- 2, 6 foot set-up poles
- 3/4" open ended wrench

INSTALLATION PROCEDURE

- Remove the hole covers located on the base by removing the 4-40 screws (see Figure 24).
- Insert the two metal poles through the holes as shown in Figure 25.
- Have one person slowly push down on the 2 poles. This will tip the Grand SLAMMs to the proper angle for caster removal and spike insertion. While one person holds the poles down have the other person stand on those poles.

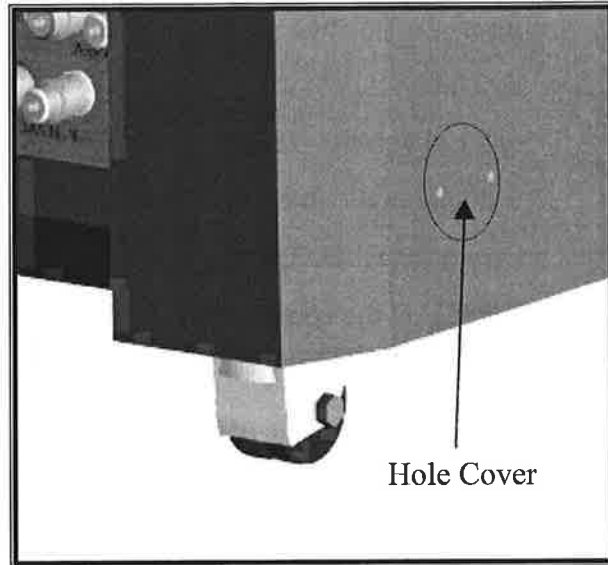

FIGURE 24 HOLE COVER ON STAND

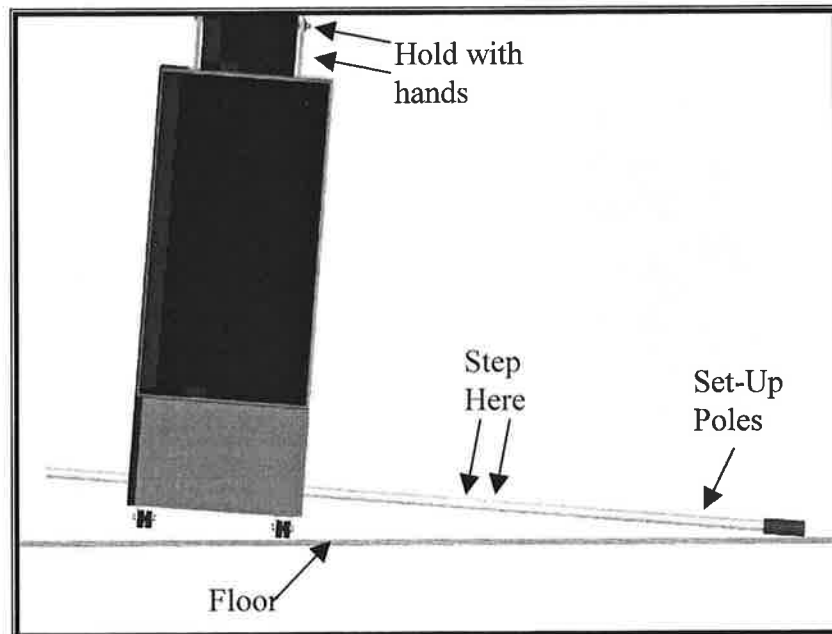

FIGURE 25 TILTING THE X-1 FOR SPIKE INSTALLATION

- Use the open-ended wrench to loosen the casters and insert the finished spike assembly. Screw in the spike assembly. Hand tighten only! Note: Be very careful NOT TO CROSS THREAD the spikes. The base of the X-1/Grand SLAMMs are made of "X" material and are prone to cross threading. Note: The spike will go into a different hole than the caster. (see Figure 26)

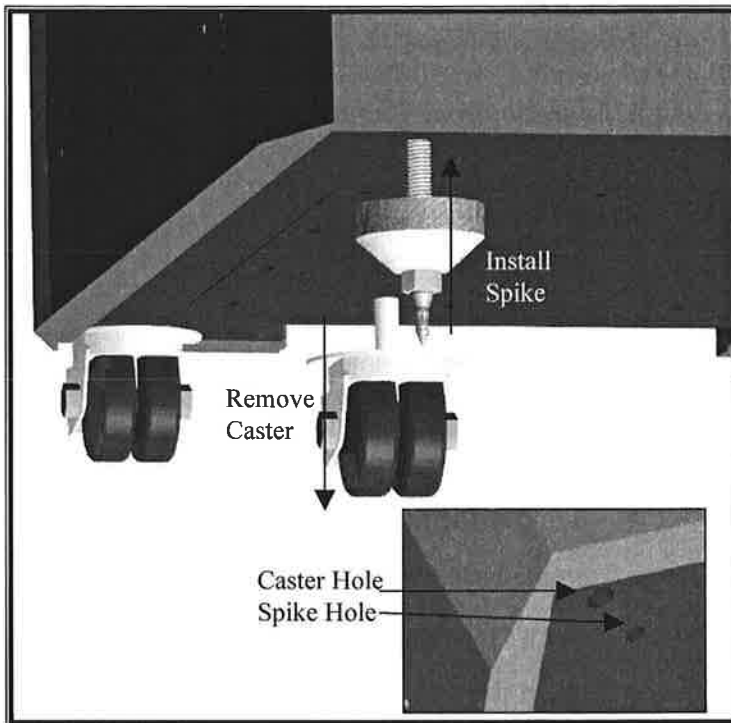

FIGURE 26 INSTALLING THE SPIKES

Perform this operation on the 2 casters that are lifted by the poles.

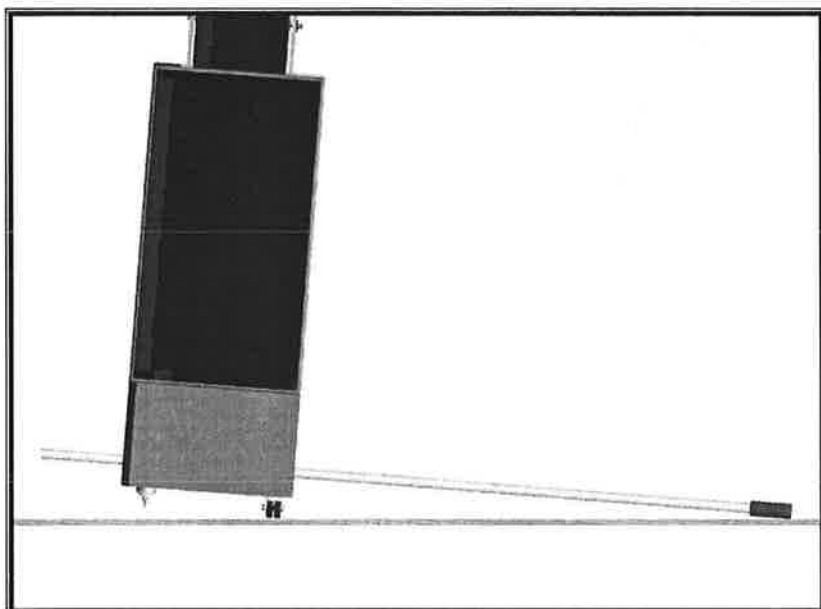

FIGURE 27 X1 TILTED WITH SPIKES INSTALLED

With one person holding the Grand SLAMMs, have the person standing on the poles grasp them in their hands. This person will now lower the X-1/Grand SLAMM onto the spikes.

Note: The X-1 Grand SLAMMs will be off-balance at this point, and you should be certain that they don't tip all the way over. USE CAUTION.

Repeat the previous process of the caster removal/spike insertion on the opposite side of the enclosure. Then continue the process on the other channel (see Figure 28).

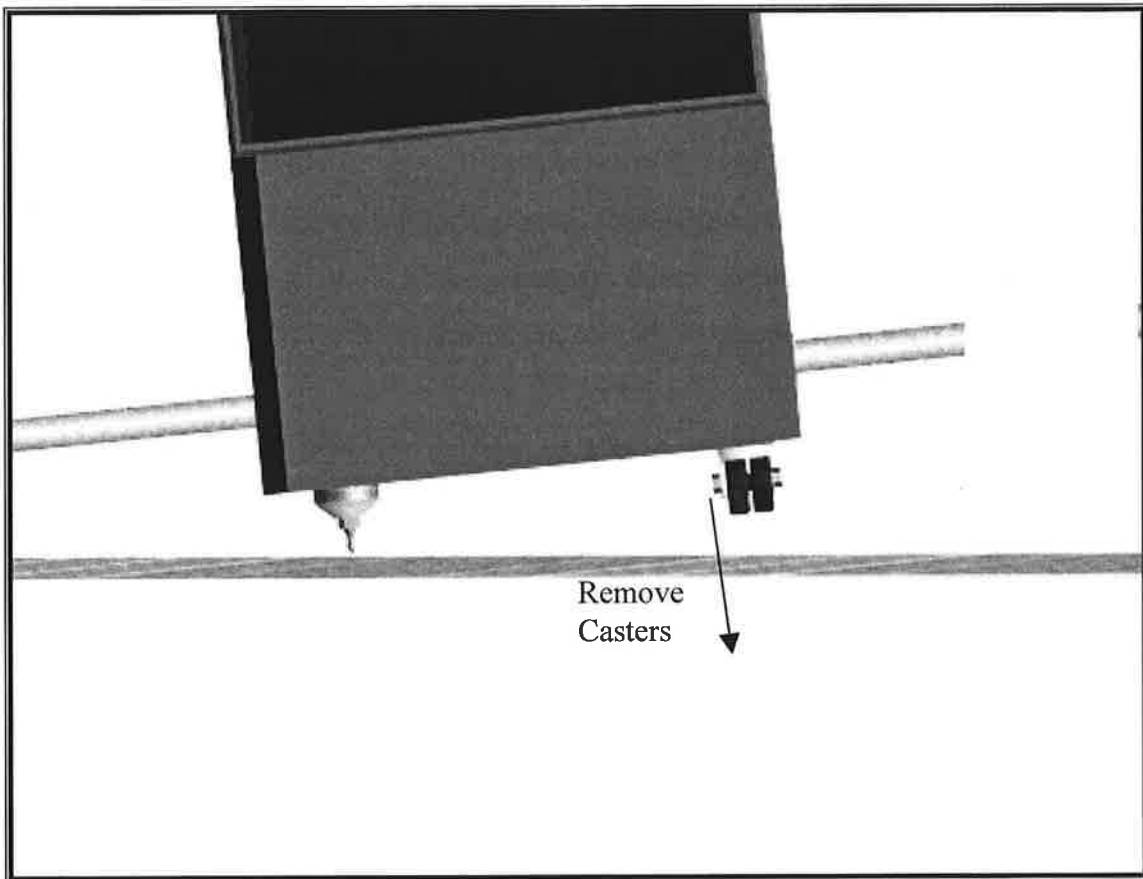

FIGURE 28 INSTALLING SPIKES ON OPPOSITE SIDE

LEVELING THE X-1/GRAND SLAMMS

- Place a level on the left to right oriented axis. If it is level, move on to the next section.
- If the bubble is leaning toward the center of the room, you will have to bring one of the outside spikes down toward the floor. If the bubble is leaning toward the outside of the room, you will have to bring one of the inside spikes down toward the floor.

Note: To find out which spike to lower grasp the Grand SLAMM channel and rock it back and forth.

- Place a level on the front to back oriented axis. If it is level then your X-1 Grand SLAMMs are level. If the bubble is leaning toward the front of the room you will have to bring one of the front spikes down toward the floor. If the bubble is leaning toward the back of the room (behind the loudspeakers) you will have to bring one of the front spikes down toward the floor.
- Your X-1/Grand SLAMMs should now be level.

SECTION 4.6-CHECKING FOR THE IMAGE HEIGHT

Once the X-1/Grand SLAMMs are properly spiked, check for the proper image height. Small differences in measurement of the listening distance can cause the image height to be too high. Check X-1 Grand SLAMMs for the correct height as follows:

- 1 Sit in your listening position and listen to a piece of vocal performance that you know well. Is the image height too high? If it is not too high, then proceed to installing the fascia on your X-1/Grand SLAMMs. If it is too high follow the next few steps. *Note: Perform the following steps on both channels of your system.*
- 2 Loosen the bolts that are holding your modules in place. You should also loosen the bolts holding the crossovers in place.
- 3 Write down the number of increments that each module is set at (i.e. lower frequency module is at 6 and 2 1/2 tics).
- 4 Starting from the lower frequency modules on each channel, move the arrays 1 1/2 increments to the front of the X-1/Grand SLAMMs. So in the case that I have stated, it would be 6 and 4 tics.
Note: If you are careful, the entire array (all 3 modules) will move 1 1/2.
- 5 Check to see that all 3 modules are correctly placed and then tighten them down on each channel. *Note: Remember to tighten all of the crossover bolts, then check the modules for tightness.*

SECTION 4.7-ATTACHING THE FASCIA'S

REQUIRED MATERIALS:

- 2, 10-32x1" screws
- 8, 10-32x1 $\frac{3}{4}$ " screws
- 10, Fascia Hole Covers
- 1, 5/32 T-handled Allen wrench

ATTACHMENT PROCEDURE:

- Insert the 10-32x1 $\frac{3}{4}$ " screws into the 4 lower holes on each fascia.
- Insert the 10-32x1" screws into the upper hole on each fascia.
- Tighten each screw firmly but do not over tighten them.
- Place the fascia hole covers over the screw heads.

Lastly, reinstall the base hole covers using the 4-40x $\frac{1}{4}$ " screws and 3/32 T-handled wrench. Again, make sure to not over tighten the screws.

Store the crates for future use, sending them back to the factory for upgrades, moving, etc.

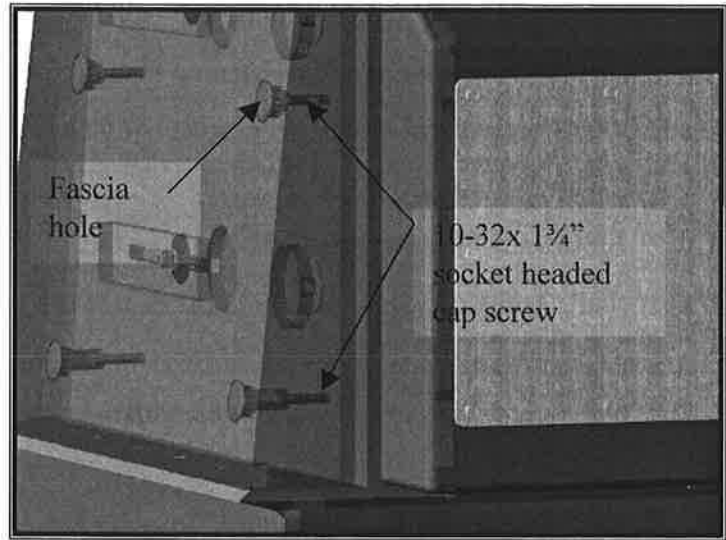

FIGURE 29 SCREW LOCATIONS ON THE FASCIA

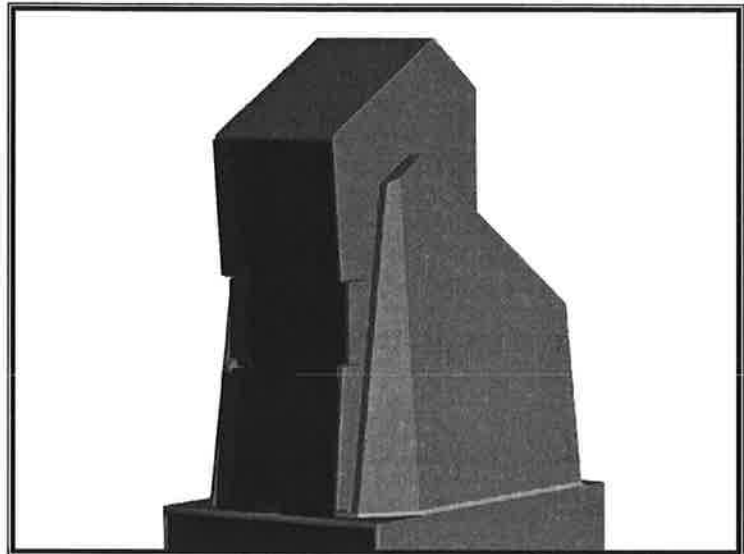
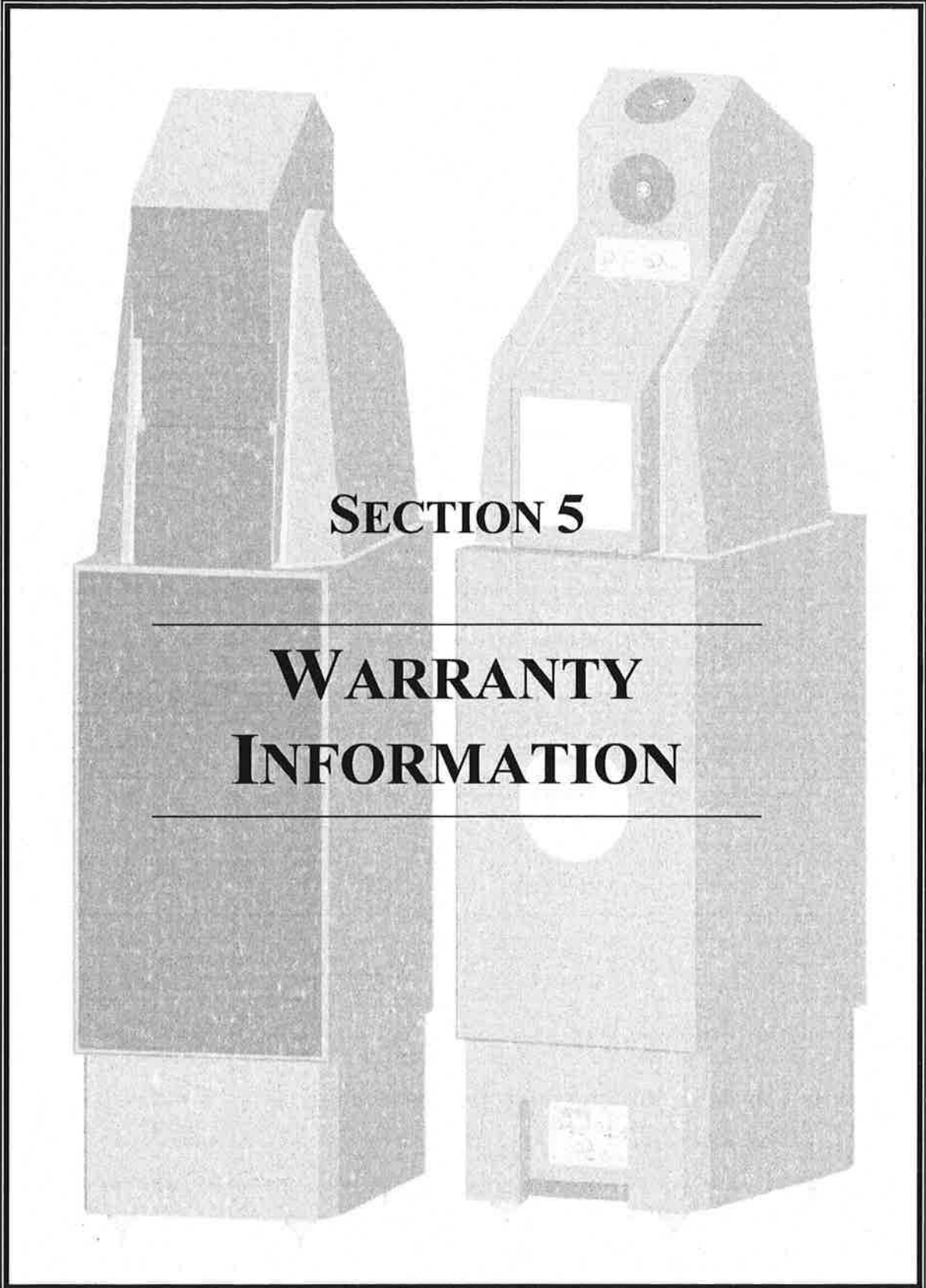

FIGURE 30 FINISHED UPPER ARRAY



SECTION 5

**WARRANTY
INFORMATION**

SECTION-5.0 WARRANTY INFORMATION

WILSON AUDIO LOUDSPEAKER

LIMITED WARRANTY

TERMS AND CONDITIONS

LIMITED WARRANTY

Wilson Audio warrants its loudspeakers to be free of manufacturing defects in material and workmanship, subject to the conditions hereinafter set forth for a period of 90 days from the date of purchase by the original purchaser, or five (5) years, if a Warranty Registration Form has been correctly filed at Wilson Audio, no later than 30 days after product delivery to the customer.

CONDITIONS

This warranty is subject to the following conditions and limitations. The Warranty is void and inapplicable if the product has been used or handled **other than** in accordance with the instructions in the owner's manual, abused or misused, damaged by accident or neglect or in being transported or the defect is due to the product being repaired or tampered with by anyone other than Wilson Audio, or an authorized repair center. Most repairs can be made in the field by an authorized Wilson Audio agent. In instances when return to Wilson Audio's factory is required, a return authorization must first be obtained by the dealer or customer. Wilson Audio will pay return freight of its choice. **A RETURNED PRODUCT MUST BE ACCOMPANIED BY A WRITTEN DESCRIPTION OF THE DEFECT.** Wilson Audio reserves the right to modify the design of any product without obligation to purchasers of previously manufactured products and to change the prices or specifications of any product without notice or obligation to any person.

REMEDY

In the event that the above product fails to meet the above Warranty and the above conditions have been met, the purchaser's sole remedy under this Limited Warranty shall be to return the product to Wilson Audio or to an authorized Wilson Audio repair center where the defect will be rectified without charge for parts or labor.

LIMITED TO ORIGINAL PURCHASER

This Warranty is for the sole benefit of the original purchaser of the covered product and shall not be transferred to a subsequent purchaser of the product. Any subsequent purchaser should contact a Wilson Audio dealer to request a new warranty.

DEMONSTRATION EQUIPMENT

Equipment used by an authorized dealer for demonstration purposes is warranted to be free of manufacturing defects in materials and workmanship for a period of five (5) years from the date of shipment to the dealer. Demo equipment needing warranty service may be repaired on-site or, if necessary, correctly packed and returned to Wilson Audio by the dealer at his sole expense. Wilson Audio will pay return freight of its choice. A returned product must be accompanied by a written description of the defect. Dealer owned demonstration equipment sold at retail within two (2) years of date of shipment to the dealer is warranted to the first retail customer to be free of manufacturing defects in materials and workmanship for the same time periods as if the product had originally been bought for **immediate** resale to the retail customer. In other words, 90 Day basic warranty, unless extended to 5 years by return of completed Warranty Registration.

MISCELLANEOUS

ANY IMPLIED WARRANTIES RELATING TO THE ABOVE PRODUCT SHALL BE LIMITED TO THE DURATION OF THIS WARRANTY. THE WARRANTY DOES NOT EXTEND TO ANY INCIDENTAL OR CONSEQUENTIAL COSTS OR DAMAGES TO THE PURCHASER. Some states do not allow limitations on how long an implied warranty lasts or an exclusion or limitation of incidental or consequential damages, so the above limitations or exclusions may not apply to you. This Warranty gives you specific legal rights, and you may also have other rights which vary from state to state.

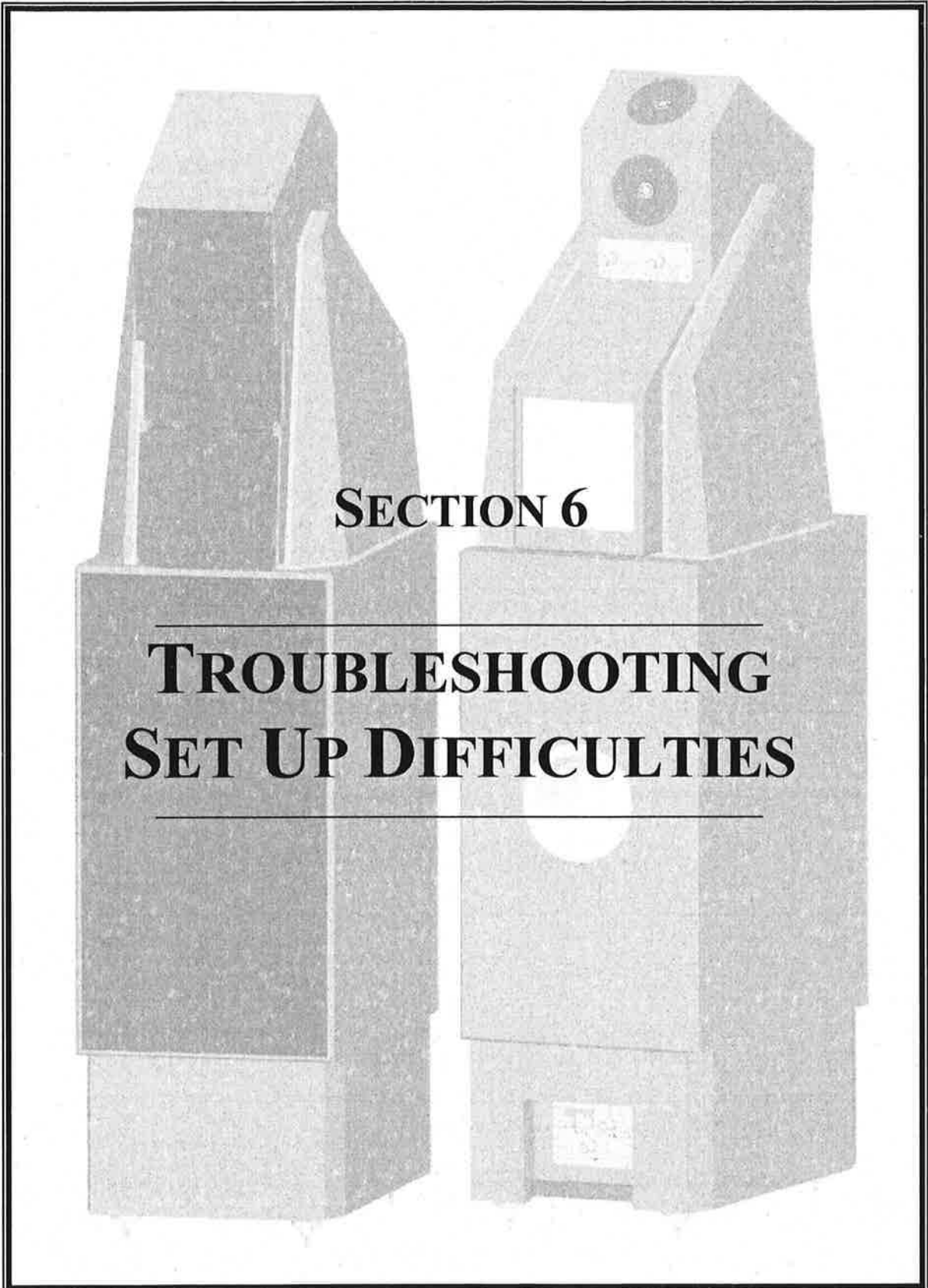

SECTION 6

**TROUBLESHOOTING
SET UP DIFFICULTIES**

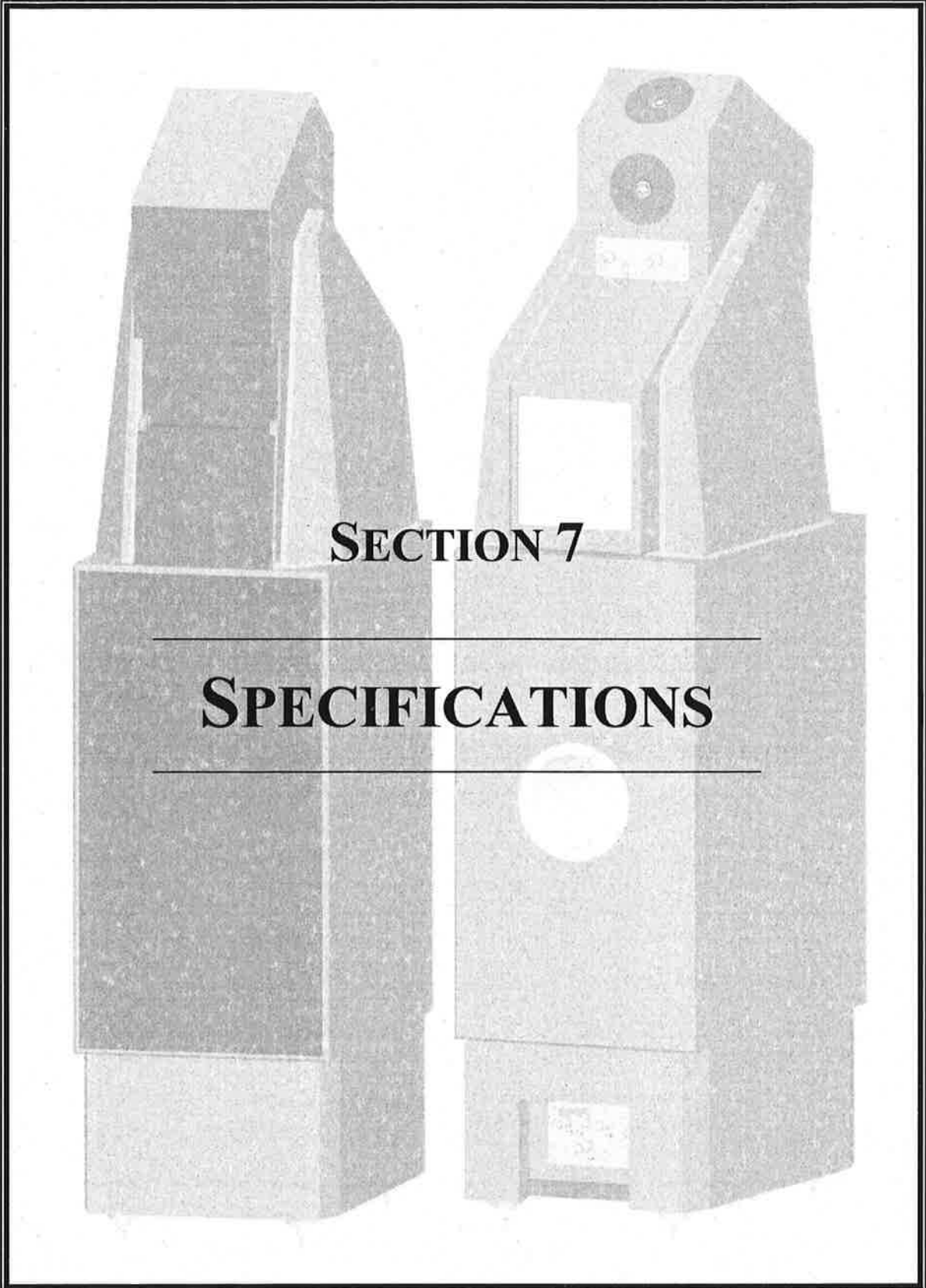

SECTION 7

SPECIFICATIONS

SECTION 7.0- SPECIFICATIONS

Enclosure Type:	Ported - Woofer Closed - Mid Frequency Closed - High Frequency
Woofer Diameter:	1 - 12 Inch, 30.5 cm 1 - 15 Inch, 38 cm
Mid Frequency Diameter:	2 - 7 Inch, 18 cm
Tweeter Diameter:	1 - 1 Inch Forward Firing 2 - 1 Inch Rearward Firing
Sensitivity:	95 dB (2.83 Volts at 1 meter)
Frequency Response:	19.5 Hz to 22.5 kHz (-3dB SPL)
Minimum Amp Power:	20 Watts/per channel
Standard Finishes:	Wilson Gloss Optional Wood side panels available
Overall Dimensions:	Height - 72 Inches, 183 cm Width - 16 1/2 Inches, 42 cm Depth - 25 1/4 Inches, 64 cm
Approximate shipping weight complete system:	1758 lbs., 797 kilograms
Approximate channel weight:	575 lbs., 261 kilograms
Warranty:	5 year transferable

APPENDIX A- TIMING CHARTS

Lower Mid-Range Module (LMRM)

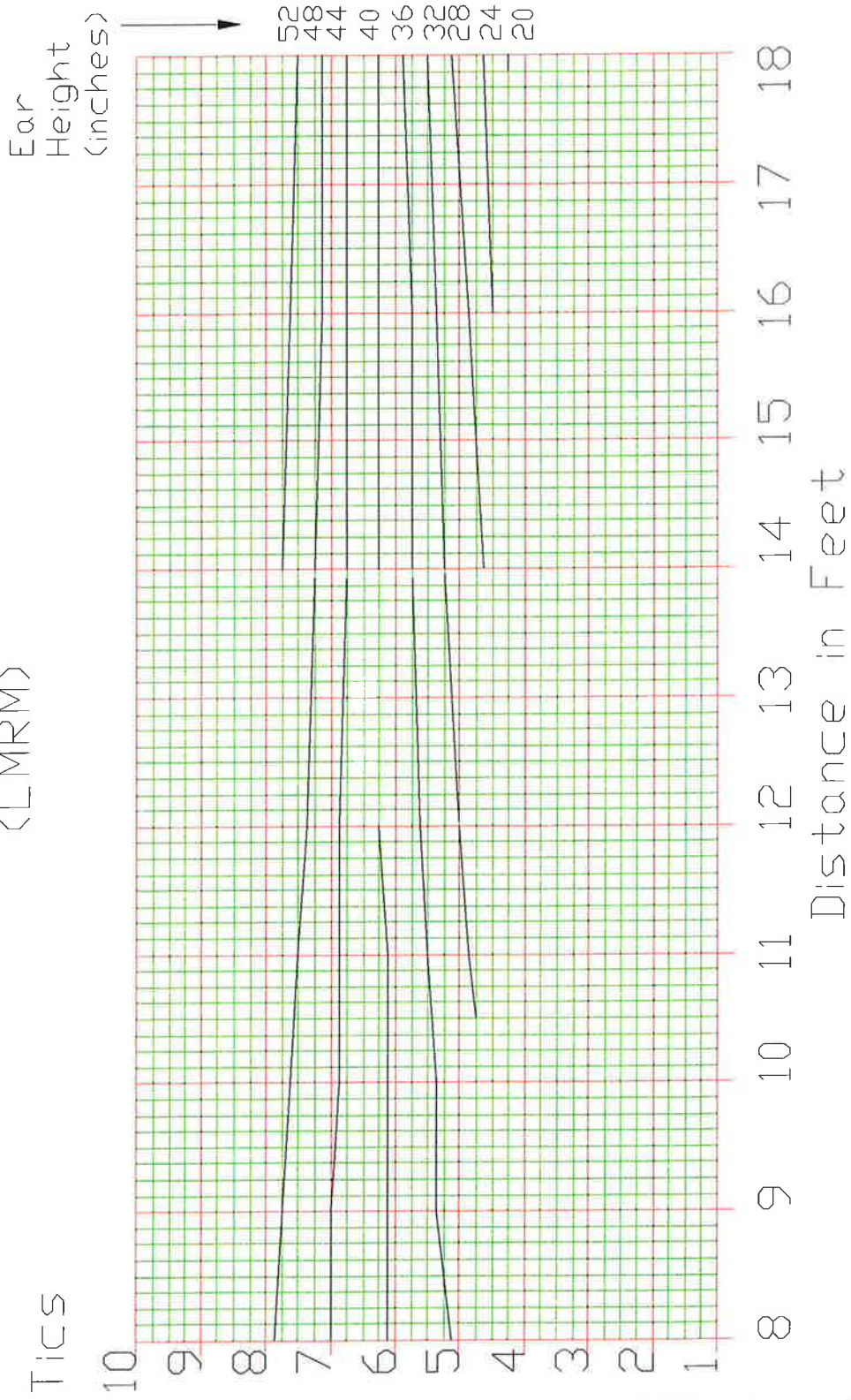

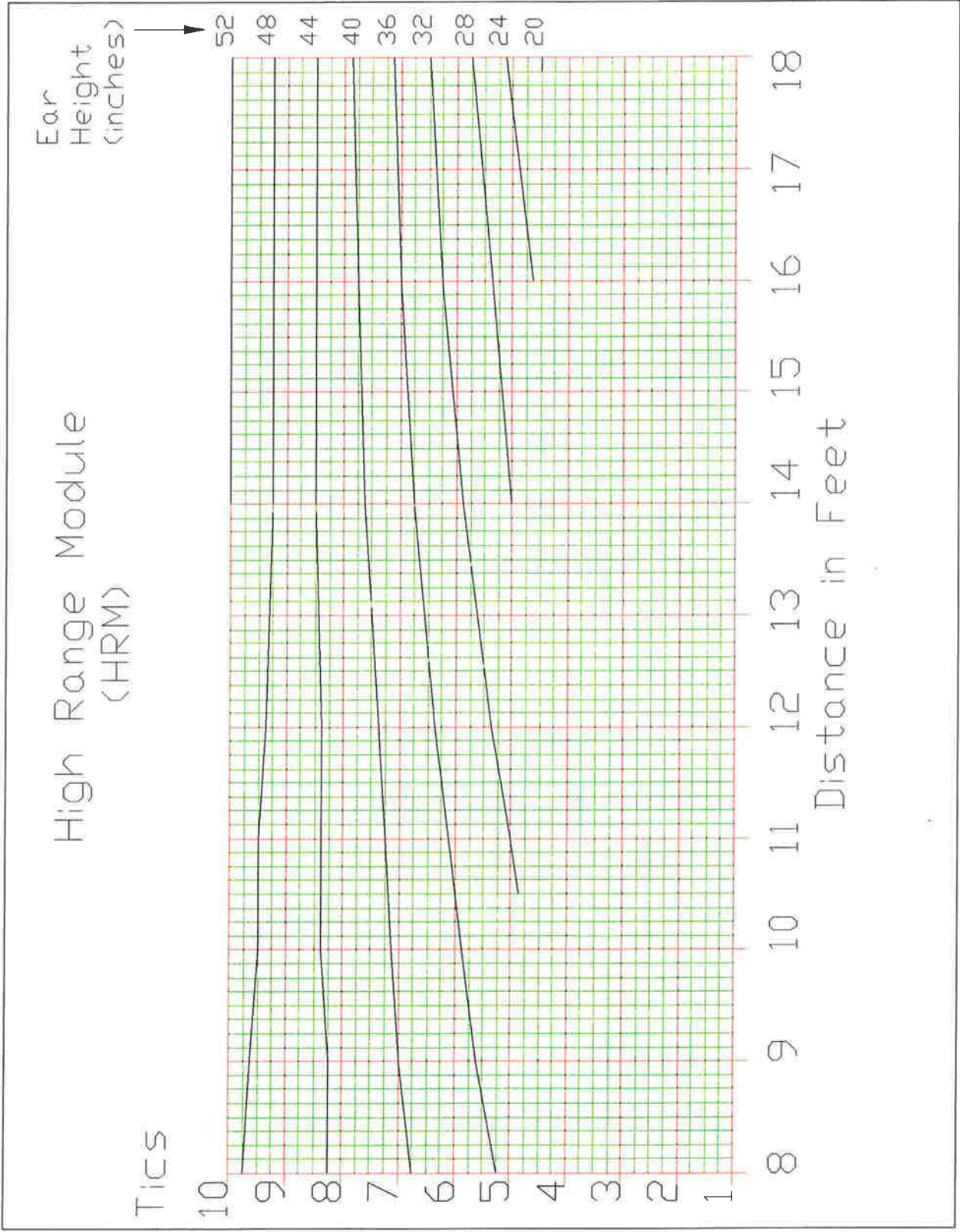

Upper Mid-Range Module (UMRM)

